

BUDGIT®

414 West Broadway Avenue
P.O. Box 769
Muskegon, Michigan 49443-0769
(800) 955-5541 • FAX (800) 742-9270

INSTRUCTIONS FOR INSTALLING SUSPENSION LUGS ON BUDGIT® COIL CHAIN ELECTRIC HOISTS

CATALOG 23456902, 905422 & 905424 SUSPENSION LUGS

GENERAL

BUDGIT Suspension Lugs are especially designed for Coil Chain Model BUDGIT Electric Hoists. They are used to convert existing hook suspended hoists to lug mounting. The suspension lug replaces the upper hook assembly permitting hoist to be bolted directly to overhead support in fixed hoist applications, or, attached to BUDGIT rigid trolleys for monorail installations.

Three sizes of suspension lugs are available as shown in Fig. 1: Catalog 23456902 is for use on 1/8 thru 1 ton capacity hoists; Catalog 905422 for 2 ton capacity hoists; and Catalog 905424 for 3 ton capacity hoists.

Lugs are easily installed following the steps described herein.

NOTE: These suspension lugs are **not to be used** with Roller Chain Model hoists.



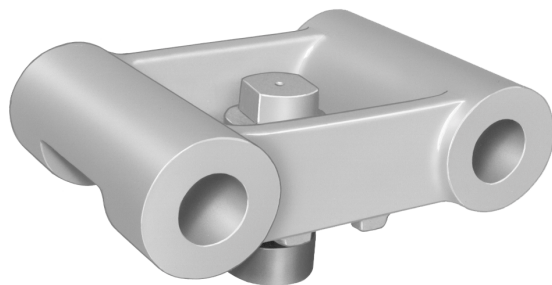
Catalog 23456902
Suspension Lug for
1/8-1 Ton Capacity Hoists

10235B



Catalog 905422
Suspension Lug for
2 Ton Capacity Hoists

11750



Catalog 905424
Suspension Lug for
3 Ton Capacity Hoists

SUSPENDING HOIST - ALL CAPACITIES

1. Stationary Lug Mounted Hoists - Select a suitable overhead support in area hoist is to be used (one capable of holding weight of hoist and its capacity load). Mount hoist using thru bolts, of appropriate size, to fit mounting holes in lug at top of hoist frame. Structure used to suspend hoist must be of sufficient strength to withstand forces to which the hoist and support may be subjected. Hoist must be aligned with load to avoid side pulls.

2. Lug Mounted Hoists With Trolleys - The trolley sides must be adjusted to fit I-beam on which hoist will operate. This is done by rearranging the spacer washers on thru bolts which connect trolley side plates to hoist mounting lug. Follow instructions furnished with trolley.

**INSTRUCTIONS FOR INSTALLING CATALOG 23456902 ADJUSTABLE SUSPENSION LUG
1/8 THRU 1 TON MODELS**

1. Remove screw securing suspension bushing keeper. Unscrew hook assembly. Use an extra thin 1 1/4" wrench, if necessary.

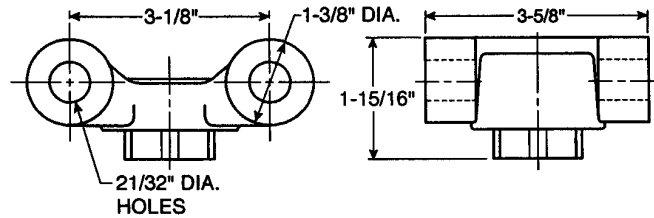
2. Place roll pins furnished with kit in hoist frame, driving them into the frame until they bottom in their holes, as shown in Figure 3.

3. Install lug assembly by threading suspension bushing into frame while guiding locking collar over pins. Thread suspension bushing all the way in, using care not to cross thread. Use a 1 1/4" extra thin wrench if necessary. The suspension bushing must be threaded completely, but does not need to be tightened. Install keeper, lock washer, and retaining screw. It may be necessary to slightly loosen the suspension bushing so that a flat lines up with the keeper plate.

Note: The suspension lug is assembled at the factory. The upper nut securing the lug to the suspension stud is pinned to prevent loosening. Do not disassemble. If replacement becomes necessary, the entire assembly must be replaced.

4. Determine whether suspension lug is to be parallel or cross mounted, Figures 4 and 5. Grooves at 90 degrees on the base of the suspension lug can be engaged by the set screw in the locking collar to hold the hoist in the cross or parallel positions. Orient the hoist as required and then tighten the set screw (using a 5/32" hex key) in the locking collar.

SUSPENSION LUG DIMENSIONS



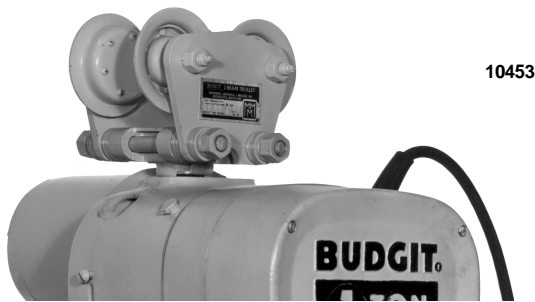
Catalog 23456902
1/8 thru 1 Ton Models



Figure 2

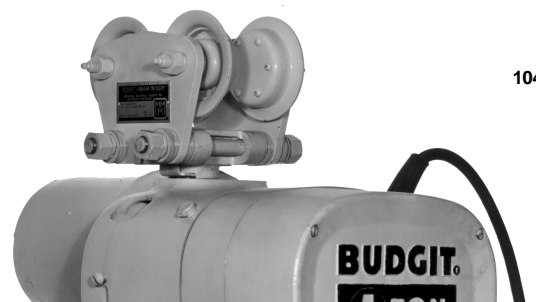


Figure 3



10453

Figure 4 - Cross Mounted



10450

Figure 5 - Parallel Mounted

INSTRUCTIONS FOR ROTATING HOIST WITH CATALOG 23456902 ADJUSTABLE SUSPENSION LUG 1/8 THRU 1 TON MODELS

1. This hoist is equipped with an adjustable lug suspension that will allow the position of the hoist, in relation to the trolley, to be changed before installation on an I-beam or while the hoist and trolley are suspended from an I-beam. No grooved pins or nuts need to be removed for adjustment.

2. The adjustable lug is attached to the hoist frame by a suspension stud and nut assembly. A locking collar is secured to the frame by two grooved pins. With the set screw in the locking collar loosened the lug will turn on the hoist frame 360 degrees. Grooves on the base of the lug at 90 degrees each can be engaged by the set screw so the collar will hold the hoist in any one of the four cross or parallel positions. To change the hoist position loosen the set screw (using a 5/32" hex key) far enough to clear the grooves. Turn the hoist frame to the desired position and secure the set screw into the bottom of the desired groove. This will allow adjustment into any of the four positions.

3. Do not remove, or, attempt to remove any grooved pins or suspension nuts. When rotation is desired, lubricate the suspension stud and thrust washer with a few drops of bar and chain oil.

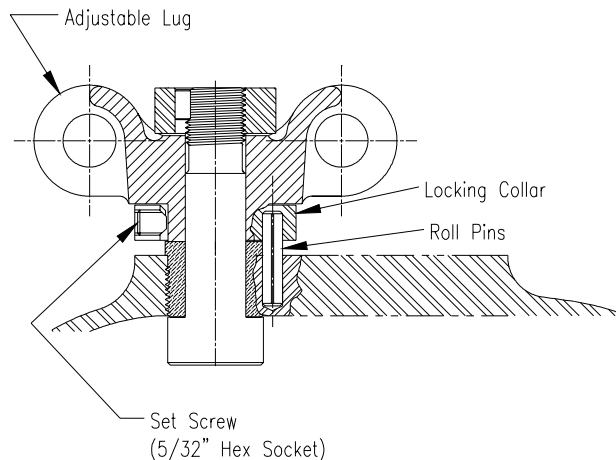


Figure 11

INSTRUCTIONS FOR INSTALLING CATALOG 905422 SUSPENSION LUG - 2 TON MODELS

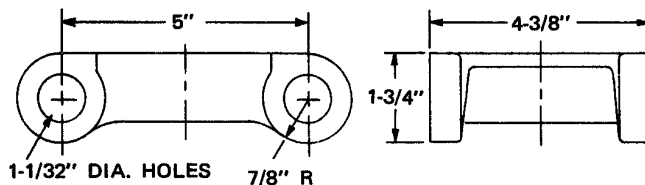
1. Remove upper hook assembly from hoist. First remove the two hex socket head screws and lockwashers securing the hook bushing lock to the upper block, Figure 6. Pull out bushing lock and unscrew hook and bushing assembly from block. The upper block assembly is not to be removed from hoist.

2. Install suspension lug assembly, Figure 7, on upper block in place of the hook.

3. Reinstall bushing lock, Figure 7, and secure with 2 hex socket head screws and lockwashers. Be certain bushing is tightened down enough so lock properly engages hex of bushing.

4. Determine whether suspension lug is to be parallel mounted on hoist or cross mounted. Align lug in selected position and install lower lock plate (provided with lug). Secure to upper bushing lock with hex socket head screw and lockwasher.

SUSPENSION LUG DIMENSIONS



Catalog 905422
2 Ton Models

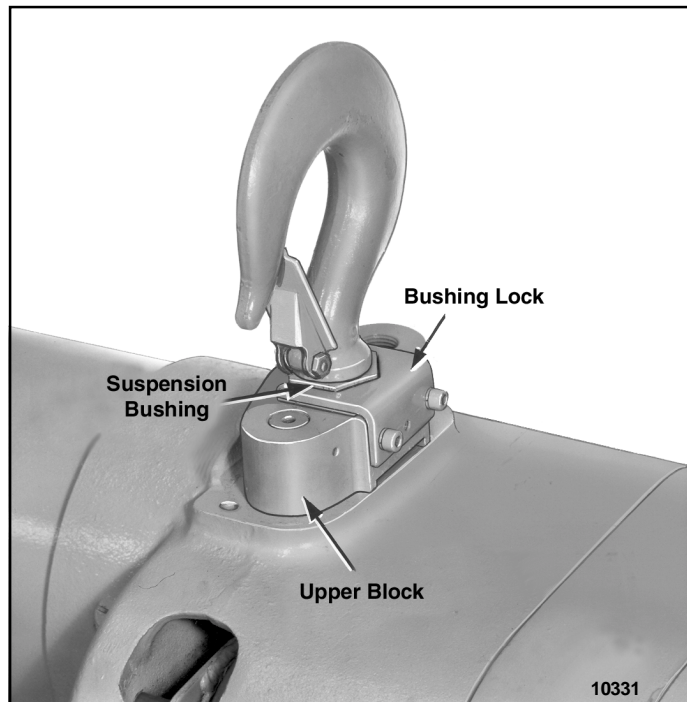


Figure 6



Figure 7

INSTRUCTIONS FOR INSTALLING CATALOG 950424 SUSPENSION LUG - 3 TON MODELS

1. Remove connecting rod pin as shown in Figure 8. Lift hanger away from hoist far enough to provide access to hook nut located under hanger. Using a drift punch, drive grooved pin thru hook nut until it hits hanger pocket. Unscrew hook while holding hook nut with drift punch partly inserted in pin hole of nut to prevent nut rotation, Figure 9. Remove hook and nut.

2. Determine whether suspension lug is to be cross mounted or parallel mounted. (See Figures 4 and 5). Place lug on hanger in desired position. Insert suspension pin through spherical washers, suspension lug and hanger as shown in Figure 10.

CAUTION

Make certain concave half of spherical washer is placed against lug.

3. Turn head of suspension pin into nut furnished with kit until grooved pin holes are aligned. (Do not use nut removed with hook). Lift lug and check clearance between lug and hanger. If clearance exceeds 1/32" (approximately), remove round nut and insert required washers above nut to obtain proper clearance when grooved pin holes line up.

4. Drive grooved pin thru nut and suspension bolt to a position flush with nut or not more than 1/8" of pin protruding.

5. Reassemble hanger to connecting rod.

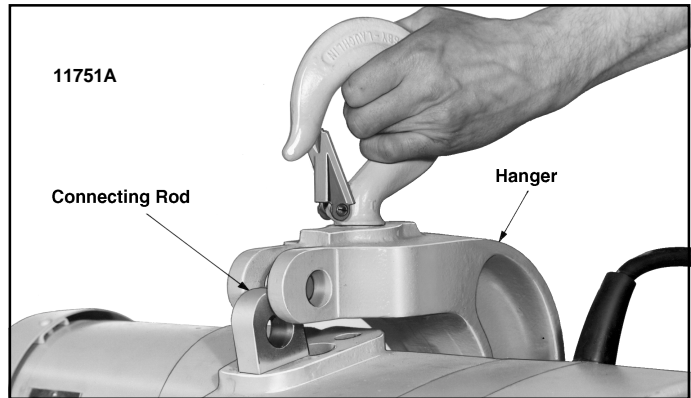


Figure 8

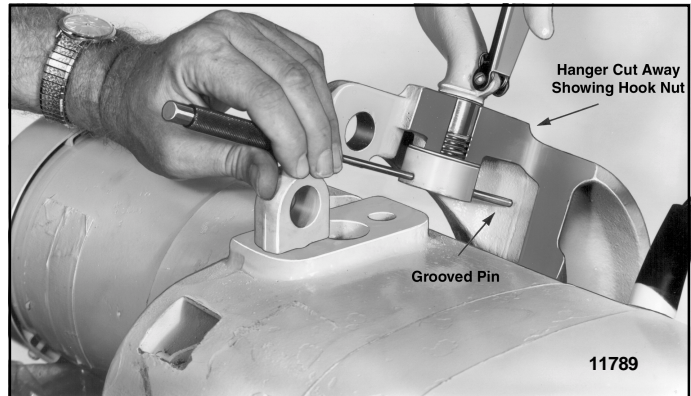
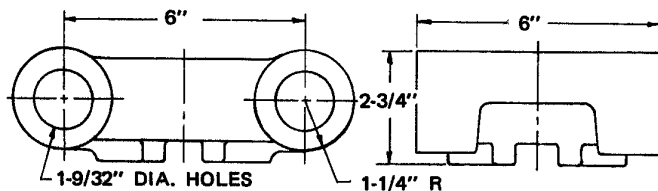


Figure 9

SUSPENSION LUG DIMENSIONS



Catalog 950424
3 Ton Models

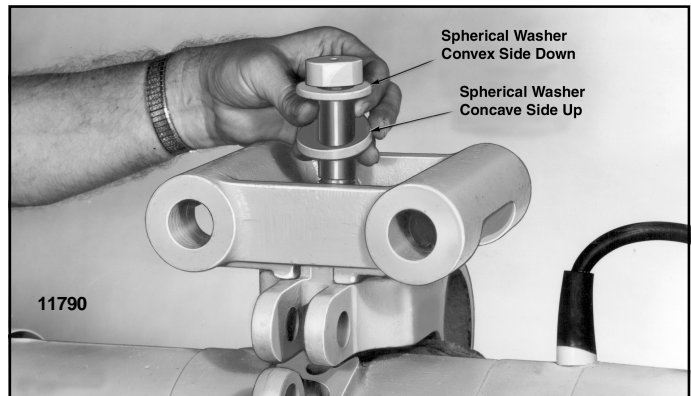


Figure 10

WARRANTY

WARRANTY AND LIMITATION OF REMEDY AND LIABILITY

A. Seller warrants that its products and parts, when shipped, and its work (including installation, construction and start-up), when performed, will meet applicable specifications, will be of good quality and will be free from defects in material and workmanship. All claims for defective products or parts under this warranty must be made in writing immediately upon discovery and in any event, within one (1) year from shipment of the applicable item unless Seller specifically assumes installation, construction or start-up responsibility. All claims for defective products or parts when Seller specifically assumes installation, construction or start-up responsibility and all claims for defective work must be made in writing immediately upon discovery and in any event, within one (1) year from completion of the applicable work by Seller, provided; however, all claims for defective products and parts made in writing no later than eighteen (18) months after shipment. Defective items must be held for Seller's inspection and returned to the original f.o.b. point upon request. THE 'FOREGOING IS EXPRESSLY IN LIEU OF ALL OTHER WARRANTIES WHATSOEVER, EXPRESS, IMPLIED AND STATUTORY, INCLUDING, WITHOUT LIMITATION, THE IMPLIED WARRANTIES OF MERCHANTABILITY AND FITNESS.

B. Upon Buyer's submission of a claim as provided above and its substantiation, Seller shall at its option either (i) repair or replace its product, part or work at either the original f.o.b. point of delivery or at Seller's authorized service station nearest Buyer or (ii) refund an equitable portion of the purchase price.

C. This warranty is contingent upon Buyer's proper maintenance and care of Seller's products, and does not extend to normal wear and tear. Seller reserves the right to void warranty in event of Buyer's use of inappropriate materials in the course of repair or maintenance, or if Seller's products have been dismantled prior to submission to Seller for warranty inspection.

D. The foregoing is Seller's only obligation and Buyer's exclusive remedy for breach of warranty and is Buyer's exclusive remedy hereunder by way of breach of contract, tort, strict liability or otherwise. In no event shall Buyer be entitled to or Seller liable for incidental or consequential damages. Any action for breach of this warranty must be commenced within one (1) year after the cause of action has accrued.

BUDGIT®