

Duff-Norton

**OPERATING & MAINTENANCE
INSTRUCTIONS
WITH PARTS LISTS
PUBLICATION PART NO. MA-680-2**

**COFFING®
HOISTS**

RATCHET LEVER HOISTS

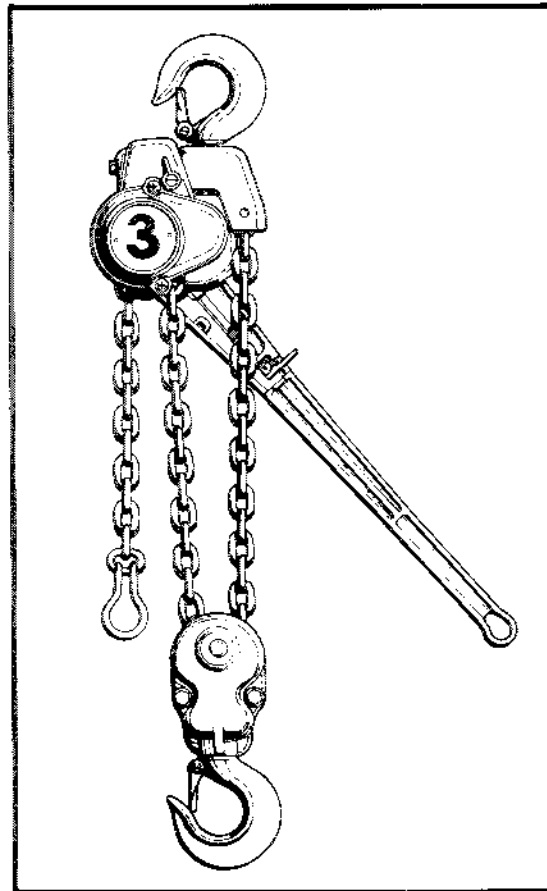

MA SERIES

IMPORTANT — CAUTION

This manual contains important information for the correct installation, operation and maintenance of the equipment described herein. All persons involved in such installation, operation, and maintenance should be thoroughly familiar with the contents. To safeguard against the possibility of personal injury or property damage, follow the recommendations and instructions of this manual and keep it for further reference.

WARNING

The equipment shown in this manual is intended for industrial use only and should not be used to lift, support, or otherwise transport people, or to suspend unattended loads over people.

TABLE OF CONTENTS

SECTION I	INTRODUCTION	3
1-1	General Information	3
1-3	Hoist Construction	3
1-5	Leading Particulars	3
SECTION II	PREPARATION FOR USE	4
2-1	Inspection Prior to Initial Use	4
2-4	Installation	4
2-6	Testing	4
SECTION III	OPERATION	4
3-1	Safety Considerations	4
3-3	Operation	4
SECTION IV	MAINTENANCE	6
4-1	Inspections	6
4-3	Frequent Inspections	6
4-5	Periodic Inspections	6
4-7	Inspection of Hoists Not in Regular Use	7
4-9	Checking Chain for Wear	7
4-11	Lubrication	7
4-13	Disassembly	8
4-21	Cleaning	12
4-23	Inspections for Excessive Wear	13
4-25	Assembly	13
SECTION V	ILLUSTRATED PARTS LIST	17
5-1	General	17

WARRANTY

Every hoist is thoroughly inspected and tested prior to shipment from the factory. Should any problems develop, return the complete hoist prepaid to your nearest Duff-Norton Authorized Warranty Repair Station. If inspection reveals that the problem is caused by defective workmanship or material, repairs will be made without charge and the hoist will be returned, transportation prepaid.

This warranty does not apply where: (1) deterioration is caused by normal wear, abuse, improper or inadequate power supply, eccentric or side loading, overloading, chemical or abrasive actions, improper maintenance or excessive heat; (2) problems resulted from repairs,

modifications or alterations made by persons other than factory or Duff-Norton Authorized Warranty Repair Station personnel; (3) the hoist has been abused or damaged as a result of an accident; (4) repair parts or accessories other than those supplied by Duff-Norton Company are used on the hoist. Equipment and accessories not of the seller's manufacture are warranted only to the extent that they are warranted by the manufacturer. EXCEPT AS STATED HEREIN, DUFF-NORTON COMPANY MAKES NO OTHER WARRANTIES, EXPRESS OR IMPLIED, INCLUDING WARRANTIES OF MERCHANTABILITY AND FITNESS FOR A PARTICULAR PURPOSE.

Coffing® and Little Mule® Authorized Warranty Repair Centers and Parts Depots

ALABAMA

- **Tool Smith Co.**
1300 4th Ave. South, Birmingham AL 35233
(205) 323-2576 (800) 317-8665 Fax (205) 323-9060

ARKANSAS

- **Hi-Speed Hoist & Crane**
710 N. Maple St, N. Little Rock AR 72114
(501) 375-9178 Fax (501) 375-4254
- **Handling Systems & Conveyers Inc.**
10909 East Otter Creek Rd. Mabelville AR 72103
(501) 455-5898 Fax (501) 455-6179

ARIZONA

- **Mechanics Tool Service**
1301 E. Apache Park Place, Tuscon AZ 85714
(520) 889-8484 AZ only (800) 372-6700 Fax (520) 889-6668

CALIFORNIA

- **Arrow Crane Hoist Corp.**
12714 South Carmenita Road, Santa Fe Springs CA 90670
(562) 921-8328 Fax (562) 921-9307
- **IDG Continental - McLaughlin**
7141 Paramount Blvd., Pico Rivera CA 90660 (Rick)
(562) 949-7881 Fax (562) 948-4448
- **Crane Works, Inc.**
2585 Nicholson Street, San Lomdro CA 94577
(510) 357-4000 Fax (510) 357-4099
- **Kimmerle Brothers, Inc.**
12060 East Florence Street, Santa Fe Springs CA 90670
(562) 946-6771 Fax (562) 944-3473
- **Kimmerle Brothers, Inc.**
226 11th Street, San Francisco CA 94103
(415) 431-1163 Fax (415) 431-1693
- **Kimmerle Brothers, Inc.**
337 "M" Street, Fresno CA 93721
(559) 233-1278 Fax (559) 233-4678

COLORADO

- **Crane Repair Co.**
3718 Norwood Drive, Littleton CO 80125
(303) 791-7918 (800) 878-7918 Fax (303) 791-7179

DELAWARE

- **Philidelphia Tramrail (Div. of Morris)**
137 Sandy Drive, Newark DE 19713
(302) 369-5819 (800) 346-2098 Fax (302) 369-5829

FLORIDA

- **J. Herbert Corp.**
1751 S. John Young Parkway, Kissimmee FL 32741
(407) 846-0588 (800) 255-0588 Fax (407) 846-1066
- **Material Handling Systems**
720 S.W. 4th Court, Dania FL 33004
(954) 921-1171 (888) 424-6478 Fax (945) 921-7117

GEORGIA

- **Ace Industries, Inc.**
6295 McDonough Drive, Norcross GA 30093
(770) 441-0898 (800) 733-2231 Fax (800) 628-3648

ILLINOIS

- **Industrial Tool Products**
919 N. Central Avenue, Wooddale IL 60191
(630) 766-4040 (800) 525-9654 Fax (630) 766-4166

- **Sievert Electric Service KSIE130 (Larry)**
1230 South Hannah, Forest Park IL 60130
(708) 771-1600 (800) 322-9144 Fax (708) 771-3124

INDIANA

- **Brehob Corp.**
1334 S. Meridian Street, Indianapolis IN 46225
(317) 231-8080 (800) 632-4451 Fax (317) 231-8072
- **Materials Handling Equipment**
7433 U.S. 30 East, Fort Wayne IN 46803
(219) 749-0475 (800) 443-6432 Fax (219) 749-0481

IOWA

- **Alter & Sons, Inc.**
514 S. Howell Street, Davenport IA 52808
(319) 323-3601 (800) 553-1111 Fax (319) 324-0138

KENTUCKY

- **Advanced Sherman**
330 North Spring St., Louisville KY 40206
(502) 896-2166 (800) 633-8186 Fax (502) 897-9837
(Kentucky only)

LOUISIANA

- **Rental Service**
3301 Cities Service Hwy., West Lake LA 70669
(318) 882-6011 Fax (318) 882-0325
- **Drilico**
12649 S. Chactaw Drive, Baton Rouge LA 70815
(504) 272-8251 (800) 851-3821 Fax (800) 315-9225

MICHIGAN

- **Continental Crane & Service Co.**
33681 Groesbeck Hwy., Fraser MI 48026
(810) 293-3870 Fax (810) 293-0017

MINNESOTA

- **Electric Motor Repair, Inc.**
2010 N. 4th Street, Minneapolis MN 55411
(612) 522-3318 (800) 345-0198 Fax (612) 588-1617
- **J & B Equipment Co. Inc.**
8200 Grand Ave. South, Bloomington MN 55420
(612) 884-2040 Fax (612) 346-1139
- **Total Tool Supply**
315 N. Pierce Street, St. Paul MN 55104
(612) 646-4055 (800) 444-4899 Fax (612) 646-8610

MISSOURI

- **Contractors Supply Co.**
800 E. 18th Street, Kansas City MO 64108
(816) 221-7788 (800) 669-7788 Fax (816) 221-0817
- **Zeller Electric KZEL125 (Dave, Sandy)**
(29985) 4250 Hoffmeister, St. Louis MO 63125
(314) 638-9641 Outside MO(800) 530-581 Fax (314) 638-6318

MONTANA

- **Industrial Tool & Repair**
2123 2nd Ave. North Billings Montana 59101
(406) 252-8114 (800) 823-8665 Fax (406) 259-3956

NEW JERSEY

- **Sissco**
186 Route 206 South, Sommerville NJ 08876
(908) 359-9767 (800) 392-0146 Fax (908) 359-9773

Coffing® and Little Mule® Authorized Warranty Repair Centers and Parts Depots Cont'd.

NEW YORK

- **ABC Electric**
24-25 46th Street, Long Island City, NY 11103
(718) 956-0000 (800) 562-1919 Fax (718) 956-4455
(New York only)
- **Beaton Industrial, Inc.**
6083 Trenton Rd., Utica NY 13502 (Rob, Jeff)
(315) 797-9346 (800) 724-4052 Fax (315) 797-932
- **Volland Electric Equipment Co.**
75 Innsbruck Drive, Buffalo NY 14227 (Brad)
(716) 656-9900 Fax (716) 656-8899

NORTH CAROLINA

- **Carolina Hoist**
3310 E. Wendover Avenue, Greensboro NC 27405
(336) 375-6050 (800) 326-3655 Fax (336) 375-6053
- **Southern Electric Service**
2225 Freedom Drive, Charlotte NC 28266 (Dave)
(704) 372-4832 (800) 487-3726 Fax (704) 342-2604

OHIO

- **Crane America-H. W. House**
920 Deneen Ave., Monroe OH 45050 (Bob, Dave, Mary)
(513) 539-9770 (800) 331-5326 Fax (513) 539-9577
- **Amerlcrane & Hoist Corp.**
13224 Enterprise Ave., Cleveland OH 44135
(216) 267-9100 (800) 652-1932 Fax (216) 267-9131

OKLAHOMA

- **Gaffey, Inc.**
6951 E. 12th Street, Tulsa OK 74112
(918) 836-6827 (800) 331-3916 Fax (918) 835-6138

OREGON

- **General Tool & Supply Co.**
2705 N.W. Nicolai, Portland OR 97210
(503) 226-3411 (800) 783-3411 Fax (503) 778-5518

PENNSYLVANIA

- **Globe Electric Co.**
200 23rd Street, Pittsburgh PA 15215
(412) 781-2677 (800) 850-4440 Fax (412) 781-1812
- **McDal Corp.**
475 East Church Rd., King of Prussia PA 19406
(610) 277-5484 (800) 626-2325 Fax (610) 277-4690
- **Repair Unlimited**
1730 Rockwell Road, Abington PA 19001
(215) 657-3335 (800) 369-5891 Fax (215) 784-0343

RHODE ISLAND

- **Motors, Hoist, & Controls Inc.**
179 Railroad Street, Woonsocket RI 02895
(401) 767-4568 Fax (401) 767-4567

SOUTH CAROLINA

- **Engineered Systems, Inc.**
125 Sunbelt Court, Greer SC 29650 (Greg)
(864) 879-7438 (800) 879-7438 Fax (864) 848-3143

TENNESSEE

- **Hoist & Crane Co.**
1106 Elm Hill Pike, Nashville TN 37210
(615) 242-3383 Fax (615) 255-4379
- **Hi-Speed Electrical Co.**
3013 Thomas Street, Memphis, TN 38127
(901) 357-6231 Fax (901) 357-6238

TEXAS

- **Abel Equipment Co., Inc.**
3710 Cavalier Drive, Garland TX 75042
(972) 272-7706 Fax (800) 272-2235
- **Gaffey, Inc.**
4301 Garland Drive, Ft. Worth TX 76117 (Jessica)
(817) 281-1994 (800) 284-4233 Fax (817) 581-7831
- **Gaffey, Inc.**
4003 S. County Rd. 1297, Odessa TX 79765
(915) 563-2897 (800) 733-0006 Fax (915) 563-4703
- **Gaffey, Inc.**
1436 N. Duck Creek Rd., Cleveland TX 77327
(281) 443-6690 (800) 233-8179 Fax (281) 592-6984
- **Hydraulic Equipment Ser.**
1021 N. San Jacinto Street, Houston TX 77002 (Tony)
(713) 228-4073 Fax (713) 228-0931

UTAH

- **Rocky Mountain Wire Rope & Rig.**
2421 South 2570 West, Salt Lake City UT 84119
(801) 972-4972 (800) 615-3193 Fax (801) 974-0621

VIRGINIA (Richmond Area)

- **Foley Material Handling Co.**
11327 Va. Crane Drive, Ashland VA 23005
(804) 798-1343 Fax (804) 798-7843

WASHINGTON

- **B & J Industrial Supply Co.**
5601 1st Avenue South, Seattle WA 98108
(206) 762-4430 (800) 767-4430 Fax (206) 762-5329

WISCONSIN

- **Alferi Industrial Sales & Service**
346 Smith Street, Neenah WI 54956 (Dewey, Bill)
(920) 722-6483 Fax (920) 722-6489

U.S. TERRITORIES (Puerto Rico)

- **Musique Express**
State Rd. 174 Block 11 No. 16, Santa Rosa Bayamen PR 00959
(787) 787-2306 Fax (787) 785-4882



P.O. Box 779 • Wadesboro, NC 28170
Parts Service: Phone 1-800-477-5004
FAX 1-800-374-6853

SECTION I INTRODUCTION

1-1. GENERAL INFORMATION.

1-2. This manual provides information for persons engaged in the operation and maintenance of a Coffing MA Ratchet Lever Hoist. All persons operating or maintaining a model MA hoist must be familiar with the information contained herein. Adherence to the precautions, procedures and maintenance practices described herein should ensure long and satisfactory use of your hoist with minimum danger to life, limb and property. If any operating or maintenance information herein seems inadequate for your particular problem please call or write our service engineers. We solicit your suggestions for improvements to this manual.

Note: The information herein is directed to the proper use, care and maintenance of the MA Hoist and does not comprise a handbook on the broad subject of rigging. Rigging can be defined as the process of lifting and moving heavy loads using hoists and other mechanical equipment. Skill acquired through specialized experience and study is essential to safe rigging operations. For rigging information, we recommend consulting a standard textbook on the subject.

1-3. HOIST CONSTRUCTION.

1-4. The body and handle of the MA hoist are made of aluminum alloy for strength without excess weight. The hoist unit is protected from load slippage because the brake mechanism is sealed against the entrance of oil, chemicals and dirt—all common causes of hoist slippage. Five seals keep the brake clean and dry, assuring constant brake performance even under conditions of exposure. Long service life is assured by the heat-treated load sheave and high tensile, heat-treated steel link chain. High quality self-lubricating bushings are used to reduce wear. The handle is secured to the hoist with a cap screw and retainer cap, not a snap ring.

1-6. This manual covers eight hoists that comprise the MA series. They are: Models MA-15, MA-15-2, MA-15-2W, MA-30, MA-30-2, MA-30-2W, MA-30-3 and MA-30-4.

1-7. The operator should be aware of the capabilities of his hoist. He must refrain from overloading. Overloading not only can cause damage to the hoist, but presents serious threats to persons around the hoist. See Table I for some leading particulars with which the operator should be familiar.

TABLE I. LEADING PARTICULARS

Model No.	Rated Capacity (Pounds)	Standard Lift (Inches)	Average Pull on Lever to Lift Full Load (Pounds)	Approximate Net Weight (Pounds)	Minimum Distance Between Hooks (Inches)	Lever Length (Inches)	Minimum Increase in Lifting Position (Inches)	Number of Chains
MA-15	1,500	60	61	14 $\frac{1}{4}$	12 $\frac{7}{8}$	20 $\frac{1}{2}$.188	1
MA-15-2	3,000	60	61	20 $\frac{1}{4}$	17	20 $\frac{1}{2}$.094	2
MA-15-2W	3,000	60	60	20	15	20 $\frac{1}{2}$.094	2
MA-30	3,000	60	82	23	15	20 $\frac{1}{2}$.088	1
MA-30-2	6,000	60	87	36	18 $\frac{3}{8}$	20 $\frac{1}{2}$.044	2
MA-30-2W	6,000	60	87	36	18 $\frac{3}{8}$	20 $\frac{1}{2}$.044	2
MA-30-3	9,000	60	90	53	23 $\frac{3}{8}$	20 $\frac{1}{2}$.029	3
MA-30-4	12,000	60	93	63	22	20 $\frac{1}{2}$.022	4

SECTION II PREPARATION FOR USE

2-1. INSPECTION PRIOR TO INITIAL USE.

2-2. Any new or repaired hoist, as well as the working area, shall be carefully inspected prior to initial installation and use. The inspection shall be made by or under the direction of a person familiar with hoist operations and industrial safety standards.

2-3. The following inspection criteria are recommended prior to initial installation and use. Additional inspection items should be added to satisfy local usage and safety requirements. All inspections of any kind should be logged or recorded, dated, signed and filed for reference purposes.

a. Ensure that the supporting structures are strong enough to carry the intended loads. The supporting structure shall have a safe load rating at least equal to that of the hoist. The supporting structure must be rigid and not subject to weakening due to repeated stresses from the hoist

b. Ensure that there is adequate working space to permit hoist operation. Normal operation should not require pulling or tugging around corners or obstructions. Also, there must be adequate space to permit the operator and other persons to stand clear of the load and adjacent structures.

c. Watch out for makeshift or compromising practices either during installation or subsequent operation of the hoist. Sometimes the "temporary" fix remains until an accident occurs.

d. Perform both the frequent and the periodic inspections specified herein on a repaired hoist prior to initial use. Perform the frequent inspections specified herein on a new hoist prior to initial use.

2-4. INSTALLATION.

2-5. Secure the hoist to a suitable supporting member by use of the top hook. Make sure that the hook latch is closed. Apply a small amount of lubriplate or equivalent between the hook and supporting member.

2-6. TESTING.

2-7. Check the hoist through a few lifting and lowering cycles with no load on the hook. Attach a load of fifty pounds to the hook and check the hoist through a few lifting and lowering cycles. Check for load drift. If brake operation is normal with this light load, test the hoist for operation with the rated load, and then with about 125 percent of the rated load. The hoist should operate smoothly and the brake should prevent load drift.

SECTION III OPERATION

3-1. SAFETY CONSIDERATIONS.

3-2. This hoist is designed for proper operation within the limits of its rated capacity. The hoist has features designed to minimize the potential for injury due to failure of the hoist itself. However, here are some additional pointers which should be followed in order to ensure proper operation.

a. Do not overload the hoist.

b. Do not use a handle extender (cheater bar). The hoist is designed to lift or pull its rated capacity when a reasonable effort is applied to the end of the handle by one person (see table I). If effort appears to be excessive recheck the load and use a larger capacity hoist if necessary.

c. Do not side load the hoist. Always pull in a straight line between hooks. Side loading over a sharp corner may fracture the hoist housing or load block.

d. Be sure there are no twists in the load chain.

e. Do not operate the hoist from an off balance position. Operator should have firm footing or be otherwise secured before operating the hoist.

f. Before raising or pulling a load, always check to see that it is held securely in the hook or sling, etc. Raise or pull the load only until the load

chain is taut and then recheck the rigging before continuing to raise the load.

g. Make sure that the slings and other rigging have sufficient capacity to support the load, and are in good condition.

h. **STAND CLEAR OF THE LOAD AT ALL TIMES.** Do not move a load in such a manner as to endanger personnel.

i. Do not leave the hoist under load for extended or unattended periods unless specific precautions have been taken to provide protection.

j. Do not wrap the load chain around a load. Use a **SLING!**

k. Do not **TIP-LOAD** any hook, as this will exert undue strain in the hook, resulting in hook failure.

l. The MA series of hoists are designed for manual operation by one person. Do not attempt to operate hoist with other than the manual power furnished by one person.

m. **DO NOT USE THE HOIST TO LIFT, SUPPORT OR OTHERWISE TRANSPORT HUMANS.**

3-3. OPERATION. (See figure 3-1.)

3-4. The hoist should be operated by qualified

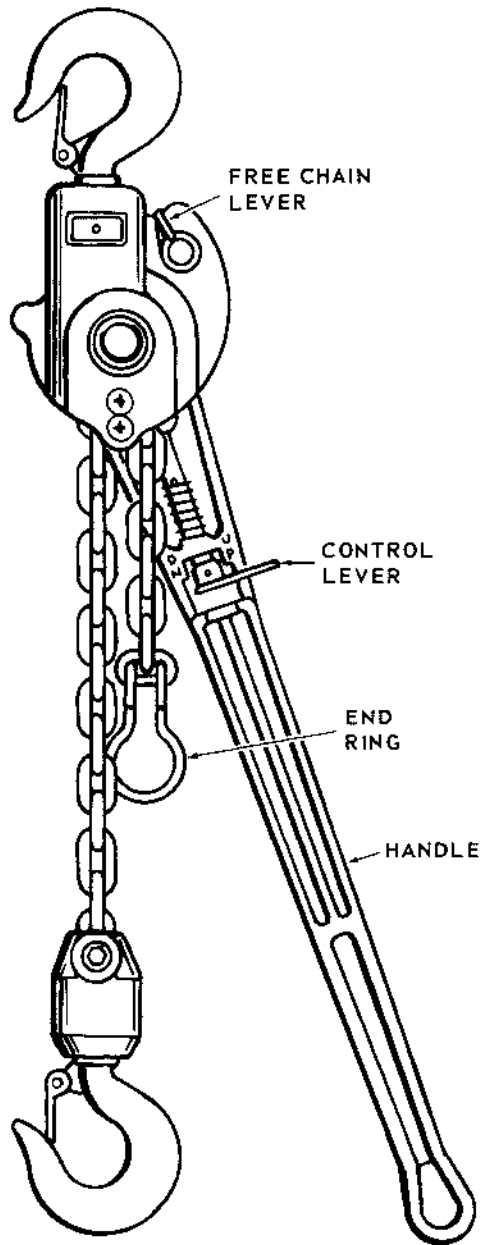

FIGURE 3-1. MA SERIES HOIST OPERATION

personnel only. The operator should familiarize himself with the hoist and its proper care. If adjustments or repairs are necessary or any damages known or suspected, he shall report the same promptly to the person authorized to correct the problem. He shall also notify the next operator of the damages upon changing shifts. If an "Out-of-Order" tag is on the hoist, the operator should not use the hoist until the tag has been removed by an authorized person. The

operator should not engage in any practice which will divert his attention while operating the hoist.

3-5. ATTACHING THE LOAD. Attach the load to the hook by means of slings or other approved devices. Make sure the slings or other devices are seated properly in the saddle of the hook before lifting. Be sure the hook latch is closed and working properly. Never wrap the load chain around the load.

3-6. TO RAISE OR PULL LOAD. Turn control lever to "UP" position as shown in figure 3-1. Operate the handle to raise the load while observing the following:

a. Before lifting or pulling, make sure the load chain is not kinked or twisted or that the load will not contact any obstructions.

b. Test the brakes each time a load approaching the rated load is handled by raising the load just enough to clear the floor, or supports, and checking for brake action.

c. Lift or pull the load to the desired position. Do not leave the hoist under load for extended or unattended periods unless specific precautions have been taken to provide protection.

3-7. TO REMOVE LOAD. Turn control lever to "DN" position, then operate handle.

CAUTION: Do not extend bottom hook beyond the hoist's rated lift. End ring should not be allowed to enter the hoist housing.

NOTE: Under certain operating conditions such as applying overload or removing the load by external means, the brake can become locked, preventing the hoist from operating in the "DN" direction. When this happens, restrain the hoist by reapplying a load to the bottom hook or lock the hoist head so that it will not move when pressure is applied to the handle. Place control lever in the "DN" position and give the handle a sharp pull. If a load is used, give the handle a few additional strokes after load has been lowered. This will insure that the brake is in an unlocked position when the load is removed from the hoist.

3-8. TO OBTAIN FREE CHAIN. To obtain free chain when there is no load on the hoist, place control lever straight out, midway between "UP" and "DN". Push free chain lever toward hook housing and hold it there. Pull free chain in either direction.

3-9. TO TAKE UP SLACK. Place control lever straight out, midway between "UP" and "DN". Pull on ring end of chain.

CAUTION-When operating the hoist keep control of the handle at all times. Do not release the handle while it is under load.

3-10. TROUBLESHOOTING. If hoist does not operate in the manner described above, see table IV for possible cause and corrective action.

SECTION IV MAINTENANCE

4-1. INSPECTIONS.

4-2. A planned inspection routine should be established for this hoist based upon frequency of use, severity of use, and environmental conditions. Some inspections should be made frequently (daily to monthly) and others periodically (monthly to yearly). It is strongly recommended that an Inspection and Maintenance Check List and an Inspector's Report similar to those shown in figures 4-4 and 4-5 be used and filed for reference. All inspections should be made by, or under the direction of a designated inspector. Special inspections should be made following any significant repairs or any operating occurrence leading one to suspect that the hoist's capabilities may have been impaired. Refer to paragraphs 4-13 and 4-25 for assistance in any disassembly and assembly necessary for inspections and subsequent replacement or repair. Prior to inspection, clean parts as required. See paragraph 4-21.

4-3. FREQUENT INSPECTIONS.

4-4. Perform the following inspections daily prior to initial use of the hoist. Also, observe during operation for any damage which might appear between regular inspections.

CAUTION: Any unsafe condition disclosed by the inspection shall be corrected before operation of the hoist is resumed. Adjustments and repairs shall be done only by designated personnel.

a. Inspect the hooks for deformations, chemical damage or cracks. Hooks damaged by chemicals, deformation or cracks, or having throat openings greater than the "Maximum Allowable Opening" shown in figure 4-1 must be replaced. If the hook is twisted more than 10 degrees from the plane of the unbent hook, it must be replaced.

Note: Any hook that is twisted or has throat openings in excess of those listed in figure 4-1 indicates abuse

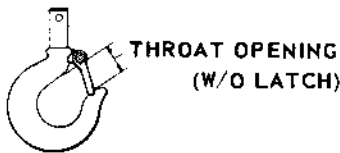

HOIST MODEL NO.	REJECT HOOK OPENING	
	TOP HOOK	BOTTOM HOOK
MA-15	1-7/32"	1-7/32"
MA-15-2	1-7/32"	1-7/32"
MA-15-2W	1-7/32"	1-7/32"
MA-30	1-13/32"	1-13/32"
MA-30-2	1-3/4"	1-3/4"
MA-30-2W	1-3/4"	1-3/4"
MA-30-3	2-5/32"	2-5/32"
MA-30-4	2-5/32"	2-5/32"

FIGURE 4-1. HOOK THROAT OPENING

or overloading of the hoist. Other load bearing components should be inspected accordingly.

b. Check that both hooks swivel freely.

c. Check the hoist handle for bends. If the handle is bent, the hoist has probably been highly overloaded. A qualified service man should inspect the hoist for other damage or return the hoist to the factory.

d. Check load chain for wear, twist and distortion and ensure that dead end ring or connection is secure. Also check the chain for presence of foreign material and adequate lubrication.

4-5. PERIODIC INSPECTIONS.

4-6. It is recommended that the following inspections be performed at one to 12 month intervals. The exact period of inspection will depend on frequency and type of usage. Determination of this period will be based on the user's experience. It is recommended that the user begin with a monthly inspection and extend the periods to quarterly, semi-annually or annually based on his monthly experience.

CAUTION: Any unsafe condition disclosed by the inspection shall be corrected before operation of the hoist is resumed. Adjustments and repairs shall be done only by designated personnel.

a. Perform all the frequent inspections listed in paragraph 4-4.

b. Check nuts, bolts and other hardware for looseness, stripped or damaged threads.

c. Check load sheave and chain attachments for distortion, cracks and excessive wear.

d. Check pawls for excessive wear, binding and missing or broken pins.

e. Check pawl springs for breaks, corrosion and continued ability to hold pawl properly.

f. Check load pawl shaft for excessive wear.

g. Inspect gear and pinion shaft for adequate lubrication, cracks, distortion, worn or broken teeth.

h. Inspect bearings for adequate lubrication, distortion, cracks and excessive wear.

i. Check housing, covers, swivel frames, load blocks and outrigger for cracks and distortion.

j. Inspect hub for damage to threads. Check hub and thrust washer for scoring or other damage to braking surfaces.

k. Check brake discs for excessive wear, glazing or oil contamination. Replace discs worn to a thickness of 5/64 inch or less.

l. Inspect seals, "o" rings and gaskets for deterioration and wear.

m. Inspect decal and capacity plate for legibility.

n. Inspect supporting structure for continued ability to support imposed loads.

o. Inspect the chain for gouges, nicks, weld splatter, corrosion and distorted links. Slacken the

chain and inspect for wear at contact points. If wear is observed, or if stretching is suspected, measure the chain per paragraph 4-10. If any portion of the chain is worn, nicked, twisted or stretched, replace the whole chain.

CAUTION: Do not attempt to reweld sections of the chain and do not try to add on to the chain. Use only chain supplied by our company, it is specially manufactured to very close tolerances of dimension, composition and heat treatment. A substitute chain may damage the load sheave. Never use "missing links" because they will jam in the load sheave.

p. Check hooks for cracks using dye penetrant, magnetic particle or other suitable detection method.

4-7. INSPECTION OF HOIST NOT IN REGULAR USE.

4-8. If the hoist has been idle for one month or more, perform the inspections listed in paragraph 4-4. If the hoist has been idle more than six months, perform the inspections listed in paragraph 4-6.

4-9. CHECKING CHAIN FOR WEAR.

4-10. Chain inspection and evaluation is a very important phase of hoist maintenance. In general, removal of the load chain from the hoist is not necessary. To check the load chain for excessive wear, proceed as follows:

a. Inspect the chain for "elongation", which is a condition caused by overloading or wear. Table II shows the normal and reject lengths for MA hoist chain. A chain gauge similar to that shown in figure 4-2 or a Vernier caliper may be used. Hang the chain up or stretch it out on a work table in a taut position. Place one edge of the gauge or caliper over the end of a chain link. The number of links within the gauge limits will correspond to the "Number of Links" as indicated in Table II. If the last link, which should be within the gauge limits, makes contact or extends past the inside edge of the gauge, or if the reading of the

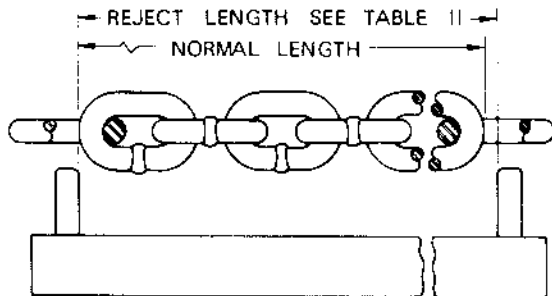

FIGURE 4-2. CHAIN SALVAGE GAUGE

Vernier caliper is equal to or greater than the "Reject Length", the entire chain shall be replaced. If the last link does not contact the edge of the gauge, or the Vernier caliper reading is less than the "Reject Length", check the chain along its entire length. If all readings are within tolerance, the chain is free of elongation.

b. Inspect each individual chain link for wear to diameter of the link. See figure 4-3. The nominal diameter of the link is 0.250 inch for the C-19-8 chain and 0.312 inch for the C-19-10 chain. If the diameter for any link of C-19-8 chain is less than 0.200 inch, replace the entire chain. If the diameter of any link of C-19-10 chain is less than 0.275 inch, replace the entire chain.

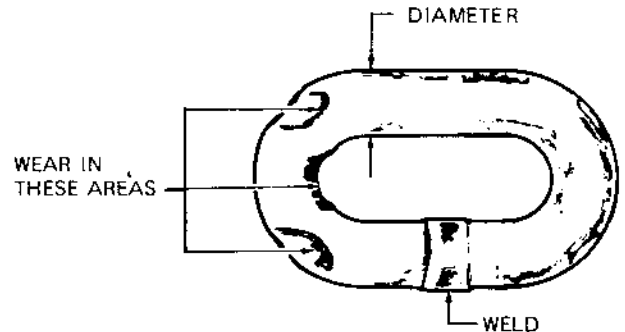

FIGURE 4-3. TYPICAL WEAR ON LINKS

4-11. LUBRICATION.

4-12. Proper lubrication is necessary for a long and relatively trouble-free hoist operation. Refer to the following and to Table III, Recommended Lubrication Schedule, for lubrication points, type of lubricant and frequency of lubrication.

a. **LOAD CHAIN.** Clean the load chain with acid-free solvent and coat with Coffing Chain Lubricant No. H-7595, or equivalent. Allow oil to work into each link end and be carried into the sheave pockets. Wipe excess oil to prevent dripping.

b. During periodic inspection apply a light coating of Coffing No. H-7577 grease to bearing surfaces of load pawl shaft; to grease seals; to o-rings; to pinion shaft and gear teeth; and to all bearings. Use H-7593 grease on gear teeth.

c. **BOTTOM HOOK BEARING.** Invert bottom hook and allow a few drops of SAE 20-30 oil to run down the hook shank and into the swivel.

d. **TOP HOOK.** Allow a few drops of SAE 20-30 oil to run down between the housing and hook shank.

TABLE II. LOAD CHAIN LINK

CHAIN PART NO.	NOM. DIA.	NO. OF LINKS	NORMAL LGTH. FOR NO. LINKS	REJECT LGTH. FOR NO. LINKS	GAUGE NUMBER
JL-19-B*	.250	19	14.776	14.957	GA-3441
C-19-10**	.312	19	17.832	18.069	GA-3441-2

*Used on MA-15, MA-15-2 and MA-15-2W. **Used on MA-30, MA-30-2, MA-30-2W, MA-30-3 and MA-30-4.

e. **BOTTOM BLOCK SHAFT AND BUSHING** (Multiple Chained Models). Disassemble bottom block to the degree required to remove shaft. Lubricate shaft and bushing with SAE 20–30 oil.

4–13. **DISASSEMBLY.**

4–14. The following paragraphs suggest the easiest method of disassembly and reassembly of the MA hoists. Procedures are included for all eight hoists in the series, with references made to the exploded view illustrations in Section V for parts identification. Use only those assembly/disassembly procedures identified as applicable to your hoist. Some procedures for one hoist may reference steps already delineated for another hoist; this is done to avoid too much repetitious procedure since all eight hoists have much common construction.

4–15. It is expected that whenever any part is removed from the hoist that the part will be cleaned and inspected before reuse. Some instructions for cleaning and inspection are located between the disassembly and reassembly paragraphs. Always give careful attention to lubrication of parts during reassembly.

4–16. **MA–15 DISASSEMBLY.** Disassemble the MA–15 hoist as follows while referencing figure 5–1.

a. Remove nut (44) and swivel screw (45). Place control lever (7) straight out, midway between “UP” and “DN” positions. Place lever (34) toward hook housing and hold it there. Pull load chain (46) by pulling end ring (47) until chain is clear of hoist. Remove end ring only if replacement is required.

b. Separate swivel frames (48) from bottom hook assembly (49). Do not remove latch (50) from bottom hook unless replacement is required.

c. Remove pin (37) from top hook (51) shaft. Separate nut (52) from top hook and remove nut, hook washer (53) and top hook. Do not remove latch (50) from top hook unless replacement is required.

d. Remove screw (1) and retainer cap (2). Remove ring (3) from retainer cap. Separate handle (10) from hub (18).

e. Punch plug (4) from handle (10). Drive pins (5 and 6) from handle pawl rod (9). Remove lever (7), spring (8) and handle pawl rod from handle.

f. Lift thread stop (11) from hub (18). Remove four screws (12) and lockwashers (13).

CAUTION: Take care not to damage sealing surfaces of cover (16) and housing (43) when removing cover.

To loosen cover (16) so that its sealing surface will not be damaged, manually turn the hub (18) clockwise. This will pull the cover loose so it can be removed by hand. Be careful not to damage the gasket (14) or oil seal (15). Remove the cover from housing and, if replacement is required, remove oil seal (15) from cover. Remove gasket (14) from housing.

g. Remove hub (18) from load sheave (32). Slide front brake disc (19), ratchet (20), rear brake disc (22) and thrust bearing (23) from load sheave. If

replacement is required, press bearing (21) from ratchet.

h. Remove spring (24) and load pawl (25) from load pawl shaft (38).

i. Remove screws (29) and lockwashers (13). Slide shedder (30) from housing (43). Remove ring (27) and washer (28) from load sheave (32) and slide load sheave from housing. Remove pin (31) from sheave.

j. Drive pin (33) from lever (34) and remove lever from shaft (38). Slide shaft from housing (43) and remove ring (35) and washer (36) from shaft. If pin (37) requires replacement, press pin from shaft.

k. If oil seal (39), thrust bearing (40), bearing (41) and pins (42) require replacement, remove these items from housing (43).

4–17. **MA–15–2 AND MA–15–2W DISASSEMBLY.** Disassemble the MA–15–2 or MA–15–2W hoist as follows while referencing figure 5–2.

a. Press pin (44) from top hook and outrigger assembly (52). Pull load chain (51) through lower sheave (61 for MA–15–2 or 70 for MA–15–2W hoist). Place control lever straight out, midway between “UP” and “DN” positions. Place lever (34) toward hook housing and hold it there. Pull load chain from hoist. Remove harness ring (50) from chain only if replacement is required.

b. (For MA–15–2 Hoist Only) Remove two nuts (55) and screws (56) and separate frames (57). Remove two pins (58) and separate shaft (59), bearing (60) and sheave (61). Remove roll pin (62) and remove nut (63) and thrust bearing (64) from hook (65). Remove latch (53) from hook only if replacement is required.

b. (For MA–15–2W Hoist Only) Remove two cotter pins (67) and separate idler pin (68), bearing (69) and sheave (70). Shear two rivets (71) and separate bottom frames (72) from bottom hook (73). Remove latch (53) from bottom hook only if replacement is required.

c. Remove two pins (45 and 46) from coupling shaft (47). Remove top hook and outrigger assembly (52), coupling shaft, hook collar (48) and washer (49) from housing (43).

d. The remainder of model MA–15–2 and MA–15–2W parts are disassembled in the same manner as the MA–15 hoist. Perform steps d thru k of paragraph 4–16.

4–18. **MA–30 DISASSEMBLY.** Disassemble the MA–30 hoist as follows while referencing figure 5–3.

a. Remove nut (51) and swivel screw (52). Place control lever (7) straight out, midway between “UP” and “DN” positions. Place lever (40) toward hook housing and hold it there. Remove load chain (53) by pulling end ring (54) until chain is clear of hoist. Remove end ring only if replacement is required.

b. Separate swivel frames (55) from bottom hook assembly (56). Do not remove latch (57) from bottom hook unless replacement is required.

c. Remove pin (59) from top hook (58) shaft.

**INSPECTION AND MAINTENANCE CHECK LIST
LEVER OPERATED CHAIN HOIST**

TYPE OF HOIST _____
 LOCATION _____
 MANUFACTURER _____

CAPACITY _____
 ORIGINAL USE DATE _____
 MANUFACTURER'S SERIAL NO. _____

ITEM	FREQUENCY OF INSPECTION			POSSIBLE DEFICIENCIES	OK	ACTION REQUIRED
	FREQUENT		PERIODIC			
	DAILY	MONTHLY	1-12 MO.			
Load Chain	*	*	*	Inadequate lubrication, excessive wear or stretch, cracked, damaged or twisted links, corrosion or foreign substance		
Hooks	*	*	*	Excessive throat opening, bent or twisted more than 10 degrees, damaged hook latch, wear, chemical damage, worn hook bearing. Cracks (use dye penetrant, magnetic particle or other suitable detection method)		
Hook Retainers			*	Worn or damaged nuts, pins, washers, collars used to secure hook in load block or housing		
Pawl, Ratchet			*	Wear and binding		
Pawl Spring			*	Breaks, corrosion, ability to retain pawl		
Brake Parts: Ratchet Brake Discs Hub Thrust Washer			*	Wear, binding, worn bearing Excessive wear, glazing, grease Scoring, thread damage Scoring, grease		
Seals, "O" Rings and Gasket			*	Wear, Deterioration		
Handle Parts: Pawl Rod Pawl Spring Handle			*	Wear, binding Breaks, corrosion, ability to keep rod in position Cracks, bends		
Nuts, Bolts, Rivets			*	Looseness, stripped or damaged threads		
Sheave, Pinion Shaft, Gear			*	Damage to teeth, distortion, cracks, excessive wear, build up of foreign substances		
Bearings			*	Adequate lubrication, wear		
Housing, Covers, Swivel Frames, Load Blocks & Outriggers			*	Cracks, Distortion		
Supporting Structure			*	Damage or wear which restricts ability to support imposed loads		
Decal, Capacity Plate			*	Missing, damaged or illegible		

NOTE: Refer to Maintenance and Inspection Sections of the Hoist Manual for further details.

FREQUENCY OF INSPECTION:

Frequent - Indicates items requiring inspection daily to monthly. Daily inspections may be performed by the operator if properly designated.

Periodic - Indicates items requiring inspection monthly to yearly. Inspections to be performed by or under the direction of a properly designated person. The exact period of inspection will depend on frequency and type of usage. Determination of this period will be based on the user's experience. It is recommended that the user begin with a monthly inspection and extend the periods to quarterly, semi-annually or annually based on his monthly experience.

FIGURE 4-4. INSPECTION AND MAINTENANCE CHECK LIST

INSPECTOR'S REPORT			
ITEM	REMARKS (LIST DEFICIENCIES AND RECOMMENDED ACTION)		
INSPECTORS SIGNATURE	DATE INSPECTED	APPROVED BY	DATE

FIGURE 4-5. RECOMMENDED INSPECTORS REPORT

TABLE III. RECOMMENDED LUBRICATION SCHEDULE

COMPONENT	TYPE OF LUBRICANT	TYPE OF SERVICE AND FREQUENCY OF LUBRICATION		
		HEAVY	NORMAL	INFREQUENT
Load Chain	D-N No. H-7595 penetrating oil with graphite or moly additive Alternate—SAE 20-30 gear oil	Daily	Weekly	Monthly
Load Pawl Shaft, Pinion Shaft, Gear and Bearings	D-N No. H-7577 grease	At periodic inspection (See Figure 4-4)		
Pinion and Gear Teeth	D-N No. H-7593 grease			
Bottom Hook Bearing	SAE 20-30 gear oil	Weekly	Monthly	Yearly
Top Hook Washer	SAE 20-30 gear oil	Monthly	Yearly	Yearly
Bottom Block Shaft and Bearing	SAE 20-30 gear oil	Monthly	Yearly	Yearly
* This lubrication schedule is based on a hoist operating in normal environmental conditions. Hoists operating in adverse atmospheres containing excessive heat, corrosive fumes or vapors, abrasive dust, etc., should be lubricated more frequently.				

CAUTION - Do not lubricate brake area of hoist.

TABLE IV. TROUBLESHOOTING CHART

IF DISASSEMBLY OF UNIT IS REQUIRED, REFER TO PARAGRAPH 4-13. TEST HOIST PER PARAGRAPH 2-6 AFTER REASSEMBLY OR REPLACEMENT OF ANY OF ITS COMPONENT PARTS.

SYMPTOM	POSSIBLE CAUSE(S)	CORRECTIVE ACTION
1. Hoist raises but will not lower.	"Brake Lock-Up" caused by shock load, leaving load on hoist for extended periods of time or removing load from hoist without slacking chain.	Unlock brake following procedure outlined on Page 3. Check application for conditions suggested in "Possible cause(s)".
2. Hoist lowers erratically.	(a) Brake friction surfaces are contaminated with oil or grease. (b) Brake discs are worn or glazed.	(a) Replace brake discs and wipe mating friction surfaces clean. (b) Replace brake discs if worn excessively, remove glaze by placing a fine grade emory cloth on a flat surface and rubbing discs lightly on this surface.
3. Hoist requires excessive effort to raise or lower.	(a) Overloading (b) Worn or damaged load chain. (c) Load Chain rusty or coated with foreign material. (d) Load sheave or guide portion of housing have build-up of foreign material. (e) Worn gearing or bearings.	(a) Reduce load or use correct capacity unit. (b) Check chain per instructions on Page 5 and replace if necessary. (c) Clean chain with suitable acid-free solvent and relubricate. Replace chain if badly pitted with rust. (d) Disassemble part and clean out foreign material. Inspect and replace parts if worn excessively. (e) Disassemble parts and check for wear. Replace parts if necessary and relubricate.
4. Hoist will not raise or lower.	(a) Chain jammed in housing (b) Broken load sheave (c) Broken or worn tip on handle pawl or stripped spline on brake hub.	(a) (b) & (c) Disassemble per instructions. Inspect parts for wear or breakage and replace if necessary.
5. Hoist "Free Chains" under load.	(a) Load pawl not engaged (free chain lever sticks) (b) Brake hub not operating freely. (c) Load chain installed from wrong side of load sheave.	(a) Check load pawl shaft for binding condition. Check for broken load pawl or load pawl spring. (b) Check thread in brake hub or mating part for damage, corrosion or foreign material. Check for broken or improperly positioned thread stop. (See Fig. 4-6) (c) Correct chain reeving. (See Fig. 4-8)
6. Hoist difficult to "Free Chain".	See 3 (b) (c) & (d)	See 3 (b) (c) & (d)

Separate nut (60) from top hook and remove nut, hook washer (61) and top hook. Do not remove latch (57) from top hook unless replacement is required.

d. Remove screw (1) and retainer cap (2). Remove ring (3) from retainer cap. Separate handle (10) from hub (18).

e. Punch plug (4) from handle (10). Drive pins (5 and 6) from handle pawl rod (9). Remove lever (7), spring (8) and handle pawl rod from handle.

f. Lift thread stop (11) from hub (18). Remove four screws (12) and lockwashers (13).

CAUTION: Take care not to damage sealing surfaces of cover (16) and housing (50) when removing cover.

To loosen cover (16) so that its sealing surface will not be damaged, manually turn the hub (18) clockwise. This will pull the cover loose so it can be removed by hand. Be careful not to damage the gasket (14) or oil seal (15). Remove the cover from housing and, if replacement is required, remove oil seal (15) from cover. Remove gasket (14) from housing. Remove decal (17) from cover only if replacement is required.

g. Remove hub (18) from pinion shaft (36). Slide front brake disc (19), ratchet (20), rear brake disc (22) and thrust washer (23) from load sheave. If replacement is required, press bearing (21) from ratchet.

h. Remove spring (24) and load pawl (25) from load pawl shaft (44).

i. Remove screws (27) and lockwashers (28), then remove cover (29). Press pins (32) from housing (50) and remove shedder (33). Remove screws (30) and capacity plate (31) if replacement is required.

j. Remove gear (34) from shaft of load sheave (37). Remove pin (35) from pinion shaft (36), then remove pinion shaft, thrust washer (38) and load sheave.

k. Drive pin (39) from lever (40) and remove lever from shaft (44). Slide shaft from housing (50) and remove ring (41) and washer (42) from shaft. If pin (43) requires replacement, press pin from shaft.

l. If oil seal (45), bearings (46, 47 and 48) and pins (49) require replacement, remove these items from housing (50).

4-19. MA-30-2 AND MA-30-2W DISASSEMBLY. Disassemble the MA-30-2 or MA-30-2W hoist as follows while referencing figure 5-4.

a. Press pin (51) from outrigger (60). Pull load chain (62) through lower sheave (70 for MA-30-2 hoist or 80 for MA-30-2W hoist). Place control lever (7) straight out, midway between "UP" and "DN" positions. Push lever (40) toward hook housing and hold it there. Pull load chain from hoist. Remove end ring (61) from chain only if replacement is required.

b. (For MA-30-2 Hoist Only) Remove two nuts (64) and screws (65) and separate load block frames (66). Remove pin (67) and separate shaft (68), bearing (69) and sheave (70). Remove pin (71), then remove nut (72), hook washer (73), and thrust bearing

(74) from bottom hook (75). Do not remove latch (59) from bottom hook unless replacement is required.

b. (For MA-30-2W Hoist Only) Remove two cotter pins (77) and separate load block shaft (78), bearing (79) and sheave (80). Shear two rivets (81) and separate load block frames (82) from bottom hook (83). Do not remove latch (59) from bottom hook unless replacement is required.

c. Remove screws (52), lockwashers (53) and keeper (54). Separate outrigger (60) from housing (50). Press pin (55) from top hook (58). Remove nut (56), washer (57) and top hook from outrigger. Do not remove latch (59) from top hook unless replacement is required.

d. The remainder of model RA-30-2 and RA-30-2W parts are disassembled in the same manner as the model MA-30 hoist. Perform steps d thru l of paragraph 4-18 to complete the disassembly.

4-20. MA-30-3 AND MA-30-4 DISASSEMBLY. Disassemble the MA-30-3 or MA-30-4 hoist as follows while referencing figure 5-5 or figure 5-6, as applicable.

a. (For MA-30-3 Hoist Only) Remove dead end screw (80, figure 5-5) and nut (66) to separate load block frames (70) from load chain (65). Pull chain through sheaves (62 and 74).

a. (For MA-30-4 Hoist Only) Remove pin (64, figure 5-6) from outrigger (63) to free end of load chain (66). Pull chain through sheaves (62 and 74).

b. Place control lever (7) straight out, midway between "UP" and "DN" positions. Push lever (40) toward hook housing and hold it there. Pull load chain (66) from hoist. Remove end ring (65) from chain only if replacement is required.

c. Remove screws (69) and nuts (68) to separate load block frames (70). Remove pin(s) (71) and disassemble shaft(s) (72), bearing(s) (73) and sheave(s) (74).

d. Remove pin (75) and separate nut (76), hook washer (77) and thrust bearing (78) from bottom hook (79). Do not remove latch (55) from bottom hook unless replacement is required.

e. Remove screws (56), lockwashers (57) and keeper (58). Separate outrigger (63) from housing (50). Disassemble pin (59), shaft (60), bearing (61) and sheave (62) from outrigger.

f. Press pin (51) from top hook (54). Remove nut (52), washer (53) and top hook from outrigger (63). Do not remove latch (55) from top hook unless replacement is required.

g. The remainder of models MA-30-3 and MA-30-4 parts are disassembled in the same manner as the model MA-30 hoist. Perform steps d thru l of paragraph 4-18 to complete the disassembly.

4-21. CLEANING.

4-22. All parts (except self lubricating bearings located in housing and bottom block assembly on

multiple chained models) may be cleaned with a pressure spray of acid-free cleaning solvent or immersed in the solvent and dried with compressed air or a clean, lintless cloth. Stubborn deposits of dirt and grease may be removed from gears, housings, chains, etc., by using a stiff-bristled brush dipped in the solvent.

CAUTION: Ensure that adequate ventilation is provided when using cleaning solutions. Wear protective clothing, and avoid prolonged contact with solvents.

4-23. INSPECTIONS FOR EXCESSIVE WEAR.

4-24. The existence of well-worn parts is sufficient reason for questioning safe hoist operation, not to mention the added costs to repair damage that will inevitably result if severe wear is permitted to continue. The parts most likely to first evidence wear are: brake discs; bushing type bearings for sheave and pinion shafts; the sheaves and their shafts and bushings; thrust bearings and washers for the hooks; pawls, ratchets and gears; and the chain and hooks. Inspection and replacement criteria for worn chain and hooks are located elsewhere in this manual.

4-25. ASSEMBLY.

4-26. Assemble parts that have been cleaned and inspected. Apply a light coating of Coffing No. H-7577 grease to o-rings, seals, bearings, apply H-7593 grease to gear and gear portion of pinion prior to assembly.

4-27. MA-15 ASSEMBLY. Assemble the MA-15 hoist as follows while referencing figure 5-1.

a. If oil seal (39), thrust bearing (40), bearing (41) or pins (42) were removed, press these items into housing (43).

b. If pin (37) was removed, press pin in shaft (38) until 1/8 inch of the pin protrudes from the top of shaft. Place washer (36) and ring (35) on shaft and insert shaft in housing (43). Secure lever (34) to shaft with pin (33).

c. Insert load sheave (32) in housing (43) and install pin (31) in load sheave. Install washer (28) and ring (27) on load sheave. Attach shedder (30) to housing with two screws (29) and lockwashers (13).

d. Place load pawl (25) on shaft (38) so that the long end of shaft pin (37) is located between pins. This allows load pawl to be moved out of engagement with the ratchet for free chaining. Install spring (24) and test the action of load pawl by turning lever (34).

e. If bearing (21) was removed, press bearing into ratchet (20) until bearing is flush with side of ratchet that fits against rear brake disc (22). Assure that the ratchet (20), thrust bearing (23), hub (18) and brake discs (19 and 22) are free of oil or other contamination. Install these parts on load sheave (32) while taking care not to get oil, grease or fingerprints on friction surfaces.

NOTE: For proper brake operation the brake hub (18) should spin down freely on the male thread of the load sheave (32) with a flick of the fingers. If excessive

effort is required remove hub and inspect threads for nicks, burrs or foreign matter.

f. Manually screw hub (18) counter-clockwise onto load sheave (32) until the hub face has locked against the brake disc (19). Continue turning hub counter-clockwise until the cast stop within the hub is at the top as shown in figure 4-6. Place thread stop (11) over the square end of the load sheave and to the right of the cast hub stop, allowing a minimum 1/8 inch movement to a maximum 5/16 inch movement between the hub stop and the protrusion on the thread stop.

g. Place gasket (14) on housing (43). If oil seal (15) was removed, press seal in cover (16). Place cover on housing while taking care not to damage oil

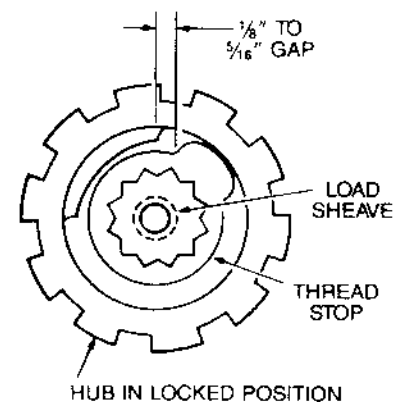

FIGURE 4-6. POSITIONING OF THREAD STOP

seal. Attach cover with four screws (12) and lockwashers (13).

h. Insert handle pawl rod (9) into handle (10). Place spring (8) on rod and press pin (5) in rod. Attach lever (7) to rod with pin (6). See figure 4-7 for correct orientation of rod and lever. Replace plug (4) in handle.

i. Install ring (3) on retainer cap (2) and secure handle (10) to hub (18) with retainer cap and screw (1).

j. Assemble top hook (51), hook washer (53) and nut (52) in housing (43). Screw nut on hook until approximately 1/64 inch vertical play (to allow hook to swivel freely) remains. Align pin hole in hook and slot in nut and insert pin (37). If latch (50) was removed, attach latch to top hook.

k. Position swivel frames (48) over bottom hook (49). If latch (50) was removed, attach latch to bottom hook.

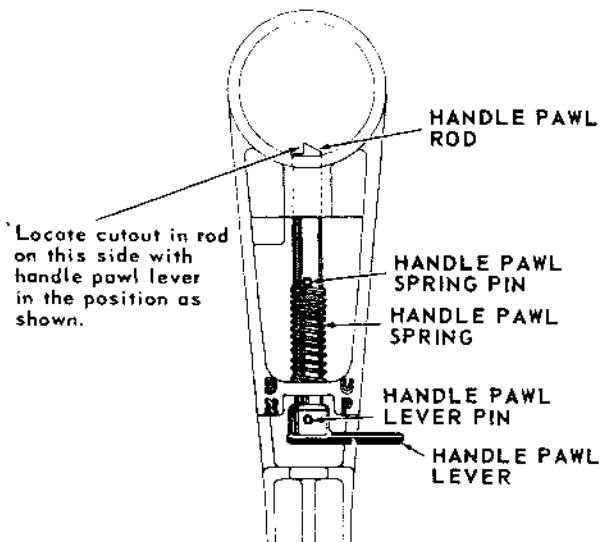

FIGURE 4-7. LEVER AND ROD ASSEMBLY

l. See figure 4-8 for diagram of chain reeving. Turn handle pawl lever to "DN" position. Invert the hoist on a work table and move handle until a flat chain pocket in the load sheave (32) can be seen. Drop loose end of the load chain into the side of load on same side as load pawl lever (34). The first link of the chain shall be upstanding in the load sheave groove, with the weld on the link facing away from the load sheave. The second link of chain should ride in one of the load sheave pockets. Use handle to turn sheave in the lowering direction. As the end of the chain moves around load sheave, turn hoist upright so load chain will move around load sheave correctly and out of housing.

m. Attach the first link of chain (46) to swivel frames (48) with swivel screw (45) and nut (44). If end ring (47) was removed, attach ring to opposite end of chain.

n. Coat the load chain with Coffing Chain Lubricant No. H-7595, or equivalent. Allow oil to work into each link and be carried into the sheave pockets. Wipe oil to prevent dripping.

o. Allow a few drops of SAE 20-30 oil to run down the bottom hook shank and into the swivel. Allow a few drops of SAE 20-30 oil to run down between housing and top hook washer.

p. Test the hoist per paragraph 2-6 before placing hoist in use.

4-28. MA-15-2 AND MA-15-2W ASSEMBLY. Assemble the MA-15-2 or MA-15-2W hoist as follows while referencing figure 5-2.

a. Perform steps a thru i of paragraph 4-27.

b. Insert coupling shaft (47) in housing (43). Place washer (49) and hook collar (48) onto end of shaft and secure with pin (45). Place top hook and outrigger assembly (52) over coupling shaft and secure with pin (46). If latch (53) was removed, attach latch to top hook.

c. (For MA-15-2 Hoist Only) Place thrust bearing (64) on bottom hook (65) and secure with nut (63). Place hook in one load block frame (57) and screw nut on hook until approximately 1/64 inch vertical play (to allow hook to swivel freely) remains. Align pin hole in hook and slot in nut and insert pin (62). Assemble shaft (59), bearing (60), sheave (61) and pins (58). Assemble load block frames (57) and hook and secure with screws (56) and nuts (55). If latch (53) was removed, attach latch to bottom hook.

c. (For MA-15-2W Hoist Only) Position two block frames (72) over hook (73) and secure with two rivets (71). Place idler pin (68), bearing (69) and sheave (70) in frames and secure with two cotter pins (67). If latch (53) was removed, attach latch to bottom hook.

d. Perform step l of paragraph 4-27.

e. Route the load chain (51) around sheave of bottom block (with chain welds next to sheave), then attach the first link of chain to top hook and outrigger assembly (52) with pin (44). Make sure there are no twists in the chain. If harness ring (50) was removed, attach ring to opposite end of chain.

f. Perform steps n, o and p of paragraph 4-27.

4-29. MA-30 ASSEMBLY. Assemble the MA-30 hoist as follows while referencing figure 5-3.

a. If oil seal (45), bearings (46, 47 and 48) or pins (49) were removed, press these items into housing (50).

b. If pin (43) was removed, press pin in shaft (44) until 1/8 inch of the pin protrudes from the top of shaft. Place washer (42) and ring (41) on shaft and insert shaft in housing (50). Secure lever (40) to shaft with pin (39).

c. Install thrust washer (38) and pinion shaft (36) in housing (50). Insert pin (35) in pinion shaft. Install load sheave (37) in housing and place gear (34) on load sheave.

d. If capacity plate (31) was removed, attach plate to cover (29) with two screws (30). Secure shedder (33) to housing (50) with two pins (32). Attach cover to housing with two screws (27) and lock-washers (28).

e. Place load pawl (25) on shaft (44) so that the long end of shaft pin (43) is located between pins. This allows load pawl to be moved out of engagement with the ratchet for free chaining. Install spring (24) and test the action of load pawl by turning lever (40).

f. If bearing (21) was removed, press bearing into ratchet (20) until bearing is flush with side of ratchet that fits against rear brake disc (22). Check that the ratchet (20), thrust bearing (23), hub (18) and brake discs (19 and 22) are free of oil or other contamination. Install these parts on pinion shaft (36) while taking care not to get oil, grease or fingerprints on friction surfaces.

NOTE: For proper brake operation the brake hub (18) should spin down freely on the male thread of the pinion shaft (36) with a flick of the fingers. If excessive effort is required, remove hub and inspect threads for nicks, burrs or foreign matter.

g. Manually screw hub (18) counter-clockwise onto pinion shaft (36) until the hub face has locked against the brake disc (19). Continue turning hub counter-clockwise until the cast stop within the hub is at the top as shown in figure 4-6. Place thread stop (11) over the square end of the pinion shaft and to the right of the cast hub stop, allowing a minimum of 1/8 inch movement to a maximum 5/16 inch movement between the hub stop and the protrusion on the thread stop.

h. Place gasket (14) on housing (50). If oil seal (15) was removed, press seal in cover (16). Place cover on housing while taking care not to damage oil seal. Attach cover with four screws (12) and lockwashers (13)

i. Insert handle pawl rod (9) into handle (10). Place spring (8) on rod and press pin (5) in rod. Attach lever (7) to rod with pin (6). See figure 4-7 for correct orientation of rod and lever. Replace plug (4) in handle.

j. Install ring (3) on retainer cap (2). Secure handle (10) to hub (18) with retainer cap and screw (1).

k. Assemble top hook (58), hook washer (61) and nut (60) in housing (50). Screw nut on hook until approximately 1/64 inch vertical play (to allow hook to swivel freely) remains. Align pin hole in hook and slot in nut and insert pin (59). If latch (57) was removed, attach latch to top hook.

l. Position swivel frames (55) over bottom hook (56). If latch (57) was removed, attach latch to bottom hook.

m. See figure 4-8 for diagram of chain reeving. Turn handle pawl lever to "DN" position. Invert the hoist on a work table and move handle until a flat pocket in the load sheave can be seen. Drop loose end of the load chain into the side of load sheave on same side as load pawl lever (40). The first link of the chain shall be upstanding in the load sheave groove, with the weld on the link facing away from the load sheave. The second link of chain should ride in one of the load sheave pockets. Use handle to turn sheave in the lowering direction. As the end of the chain moves around load sheave, turn hoist upright so load chain will move around load sheave correctly and out of housing.

n. Attach the first link of chain (53) to swivel frames (55) with swivel screw (52) and nut (51). If end ring (54) was removed, attach ring to opposite end of chain.

o. Perform steps n, o and p of paragraph 4-27.

4-30. MA-30-2 AND MA-30-2W ASSEMBLY. Assemble the MA-30-2 or MA-30-2W hoist as follows while referencing figure 5-4.

a. Perform steps a thru j of paragraph 4-29.

b. Assemble top hook (58), washer (57) and nut (56) in outrigger (60). Screw nut on hook until approximately 1/64 inch vertical play (to allow hook to swivel freely) remains. Align pin hole in hook and slot in nut and insert pin (56). If latch (59) was removed, attach latch to top hook.

c. Position outrigger (60) in housing (50) and secure with keeper (54), lockwashers (53) and screws (52).

d. (For MA-30-2 Hoist Only) Place thrust bearing (74) on bottom hook (75) and secure with nut (63). Place hook in one load block frame (66) and screw nut on hook until approximately 1/64 inch vertical play (to allow hook to swivel freely) remains. Align pin hole in hook and slot in nut and insert pin (67). Assemble shaft (68), bearing (69), sheave (70) and pin (67). Assemble load block frames (67) and hook and secure with screws (65) and nuts (64). If latch (59) was removed, attach latch to bottom hook.

d. (For MA-30-2W Hoist Only) Position two load block frames (82) over hook (83) and secure with two rivets (81). Place load block shaft (78), bearing (79) and sheave (80) in frames and secure with two cotter pins (77). If latch (59) was removed, attach latch to bottom hook.

e. Perform step m of paragraph 4-29.

f. Route the load chain (62) around sheave of bottom block (with chain welds next to sheave), then attach the first link of chain to outrigger (60) with pin (51). If end ring (61) was removed, attach ring to opposite end of chain.

g. Perform steps n, o and p of paragraph 4-27. 4-31. MA-30-3 AND MA-30-4 ASSEMBLY. Assemble the MA-30-3 or MA-30-4 hoist as follows while referencing figure 5-5 or figure 5-6, as applicable.

a. Perform steps a thru j of paragraph 4-29.

b. Assemble top hook (54), washer (53) and nut (52) in outrigger (63). Screw nut on hook until approximately 1/64 inch vertical play (to allow hook to swivel freely) remains. Align pin hole in hook and slot in nut and insert pin (51). If latch (55) was removed, attach latch to top hook.

c. Assemble sheave (62), bearing (61), shaft (60) and pin (59) in outrigger (63). Position outrigger in housing (50) and secure with keeper (58), lockwashers (57) and screws (56).

d. Place thrust bearing (78), hook washer (77) and nut (76) on bottom hook (79). Place hook in one load block frame (70) and screw nut on hook until approximately 1/64 inch vertical play (to allow hook to swivel freely) remains. Align pin hole in hook and slot in nut and insert pin (75). Assemble shaft(s) (72), bearing(s) (73), sheave(s) (74) and pin(s) (71). Assemble load block frames (70) and hook and secure with screws (69) and nuts (68). If latch (55) was removed, attach latch to bottom hook.

e. Perform step m of paragraph 4-29.

f. On the model MA-30-3 hoist route chain

thru sheave (74), thru sheave (62) and then attach loose end to bottom block with dead end screw (80) and nut (66). On the model MA-30-4 hoist route chain thru first sheave (74) in load block, then thru sheave

(62), back thru second sheave (74) in load block, then attach loose end of chain to outrigger (63) with pin (64).

g. Perform steps n, o and p of paragraph 4-27

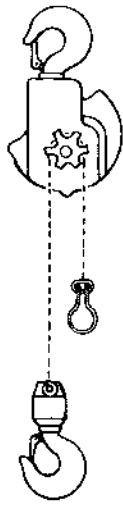

MA-15

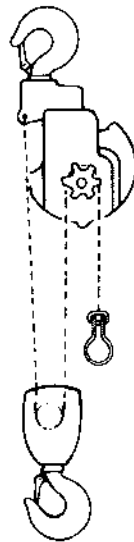

MA-15-2 & MA-15-2W

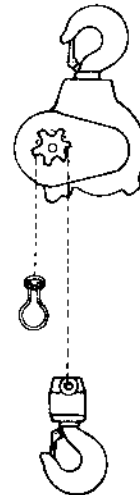

MA-30

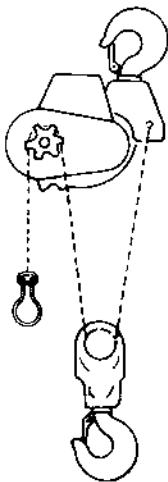

MA-30-2 & MA-30-2W

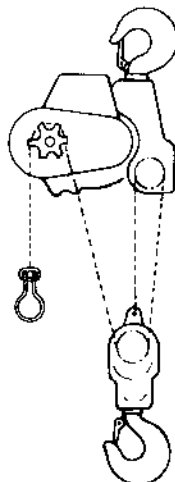

MA-30-3

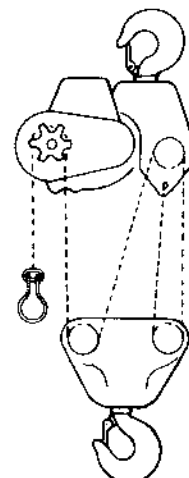

MA-30-4

FIGURE 4-8. CHAIN REEVING

**SECTION V
ILLUSTRATED PARTS LISTS**

5-1. **GENERAL.**

5-2. Exploded illustrations of the eight Model MA Hoists follow. The number adjacent to each part is the index number. Keyed to this index number on the

following page is the part name and quantity required. To order parts for your hoist please see the current parts list.

PARTS LIST FOR MODEL MA-15 HOIST

Index No.	Part Name	Qty. Req.	Part No.
1	Screw	1	H-2989-P
2	Retainer Cap	1	MA-100
3	"O" Ring, Retainer Cap	1	H-5608
4**	Plug, Handle	1	MA-254
5**	Pin, Handle Pawl Spring	1	H-5249
6**	Pin, Handle Pawl Lever	1	H-5250
7**	Lever, Handle Pawl	1	MA-31
8**	Spring, Handle Pawl	1	MA-311
9**	Handle Pawl Rod	1	MA-4
10**	Handle	1	MA-1
10A	Warning Decal	1	687K6
11	Thread Stop	1	MA-251-1
12	Screw, Cover	4	H-1882-P
13	Lockwasher	2	H-4134
14	Gasket, Housing	1	MA-560
15**	Oil Seal	1	MA-562
16*	Cover, Housing	1	MA-11
18	Hub	1	MA-35
19	Brake Disc, Front	1	MA-580-1
20*	Ratchet	1	MA-7
21**	Bearing, Ratchet	1	MA-530
22	Brake Disc, Rear	1	MA-580
24	Spring, Load Pawl	1	MA-310
25	Load Pawl	1	MA-25
27	Ring, Load Sheave	1	H-5506
28	Washer, Retaining	1	MA-250
29	Screw, Shedder	2	H-1847-P
30	Shedder	1	MA-37
32	Load Sheave	1	MAL-16-6
33	Pin, Load Pawl Lever	1	H-5240
34	Lever, Load Pawl	1	MA-32
35**	"O" Ring, Load Pawl Shaft	1	H-5607
36	Washer, Load Pawl Shaft	1	MA-252
37**	Pin	2	H-5251
38*	Shaft, Load Pawl	1	MA-26

Index No.	Part Name	Qty. Req.	Part No.
39**	Oil Seal, Housing	1	MA-561
40**	Bearing, Load Sheave	1	RA-534
41**	Bearing, Load Sheave	1	MA-531
42	Pin, Housing	2	H-5384
43*	Housing	1	MA-18
44**	Nut	1	H-3472-P
45**	Swivel Screw	1	JF-700
46	Load Chain	1	JL-19-B
47	End Ring	1	MA-75
48**	Swivel Frame	2	MA-20-1
49**	Hook Assembly, Bottom (Includes Index No. 50)	1	3K8S
50**	Latch Kit	2	H-7540
51	Hook Assembly, Top (Includes Index No. 50)	1	MA-3-10S
52	Nut, Top Hook	1	H-3986-P
53	Washer, Top Hook	1	JF-260
54	Capacity Decal	1	675K71
55†	Housing Cover and Oil Seal Assembly (Includes Index Nos. 15 and 16)	1	MA-950
56†	Ratchet Assembly (Includes Index Nos. 20 and 21)	1	MA-901
58†	Housing, Bearings and Oil Seal Assembly (Includes Index Nos. 39, 40, 41 and 43)	1	MA-951
59†	Handle Assembly (Includes Index Nos. 4 thru 10)	1	MA-908
60†	Load Block Assembly (Includes Index Nos. 44, 45 and 48 thru 50)	1	MA-913-20
61†	Load Pawl Shaft Assembly (Includes Index Nos. 35, 37 and 38)	1	MA-900

* Not sold separately as a repair part. If replacement is required, procure the appropriate following assembly.

** Sold individually as a repair part and as a part of the appropriate following assembly.

† Assembly not indexed on illustration.

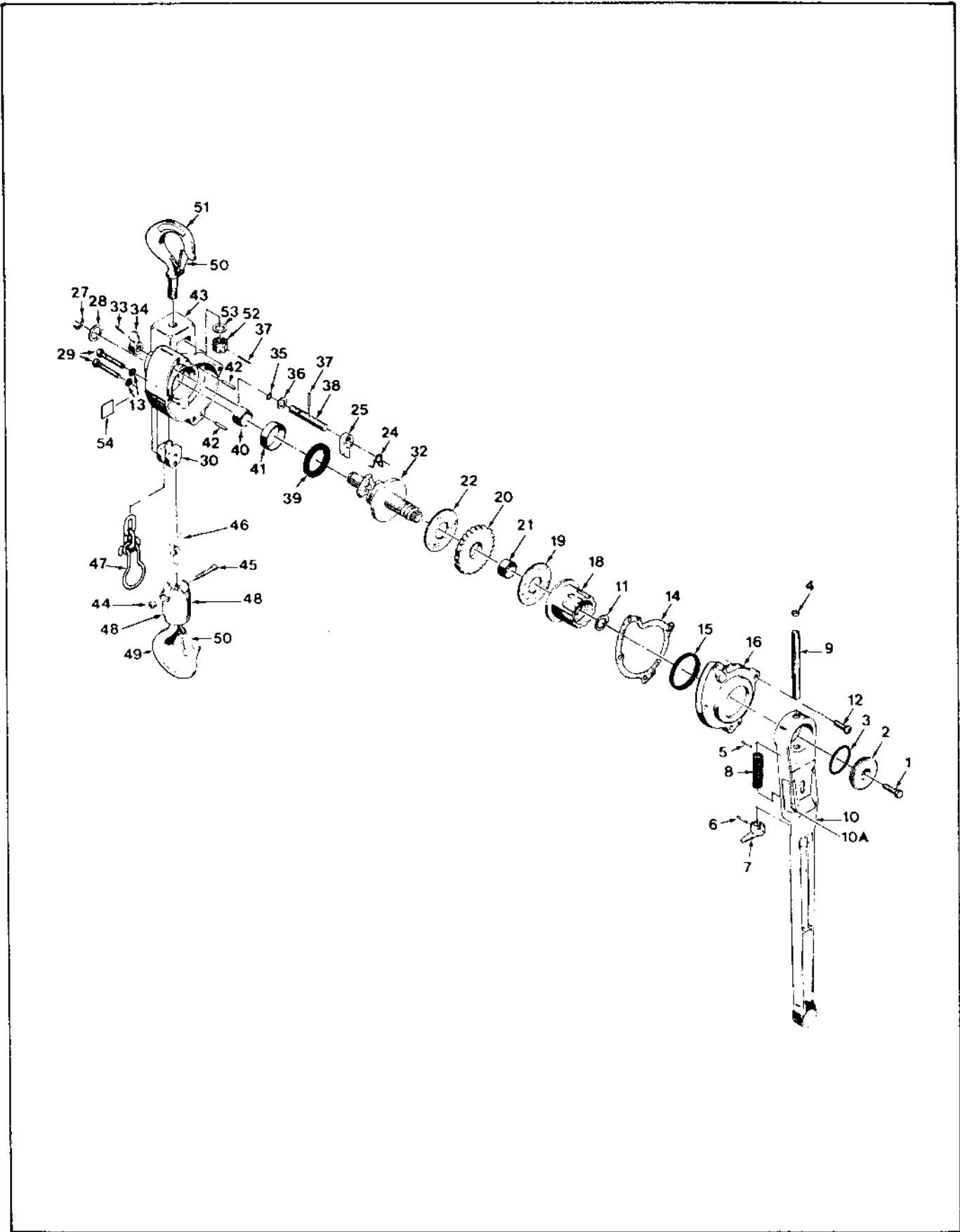

FIGURE 5-1. EXPLODED ILLUSTRATION OF MODEL MA-15 HOIST

PARTS LIST FOR MODEL MA-15-2 AND MA-15-2W HOISTS

Index No.	Part Name	Qty. Req.	Part No.
1	Screw	1	H-2989-P
2	Retainer Cap	1	MA-100
3	"O" Ring, Retainer Cap	1	H-5608
4**	Plug, Handle	1	MA-254
5**	Pin, Handle Pawl Spring	1	H-5249
6**	Pin, Handle Pawl Lever	1	H-5250
7**	Lever, Handle Pawl	1	MA-31
8**	Spring, Handle Pawl	1	MA-311
9**	Handle Pawl Rod	1	MA-4
10**	Handle	1	MA-1
10A	Warning Decal	1	687K6
11	Thread Stop	1	MA-251-1
12	Screw, Cover	4	H-1882-P
13	Lockwasher	2	H-4134
14	Gasket, Housing	1	MA-560
15**	Oil Seal	1	MA-562
16*	Cover, Housing	1	MA-11
18	Hub	1	MA-35
19	Brake Disc, Front	1	MA-580-1
20*	Ratchet	1	MA-7
21**	Bearing, Ratchet	1	MA-530
22	Brake Disc, Rear	1	MA-580
24	Spring, Load Pawl	1	MA-310
25	Load Pawl	1	MA-25
27	Ring, Load Sheave	1	H-5506
28	Washer, Retaining	1	MA-250
29	Screw, Shedder	2	H-1847-P
30	Shedder	1	MA-37
32	Load Sheave	1	MAL-16-6
33	Pin, Load Pawl Lever	1	H-5240
34	Lever, Load Pawl	1	MA-32
35**	"O" Ring, Load Pawl Shaft	1	H-5607
36	Washer, Load Pawl Shaft	1	MA-252
37**	Pin	2	H-5251
38*	Shaft, Load Pawl	1	MA-26
39**	Oil Seal, Housing	1	MA-561
40**	Bearing, Load Sheave	1	RA-534
41**	Bearing, Load Sheave	1	MA-531
42	Pin, Housing	2	H-5384
43*	Housing	1	MA-18
44	Pin	1	H-5123
45	Pin	1	H-5122-P
46	Pin	1	H-5129-P
47	Coupling Shaft	1	MA-106
48	Hook Collar	1	JF-108
49	Washer	1	JF-260
50	End Ring	1	MA-75
51	Load Chain	1	JL-19-B

Index No.	Part Name	Qty. Req.	Part No.
52	Top Hook and Outrigger Assembly (Includes Index No. 53)	1	MA-915-17
53**	Latch Kit	2	H-7540
54†	Load Block Assembly (Consists of Index Nos. 55 thru 65)	1	JF-914-7
55	Nut	2	H-3473-P
55A	Lockwasher	2	H-4063-P
56	Screw	2	H-2403-P
57	Load Block Frame	2	JF-30
58**	Pin	2	H-5234
59**	Shaft	1	JF-122-1
60**	Bearing	1	HJ-16-B
61*	Sheave	1	B-57-1
62	Pin	1	H-5251
63	Nut	1	H-3986-P
64	Thrust Bearing	1	JF-510
65	Bottom Hook (Includes Index No. 53)	1	3K6S
66†	Load Block Assembly (Consists of Index Nos. 67 thru 73)	1	BBB-57-2
67	Cotter Pin	2	H-5029
68	Idler Pin	1	HJ-28-A
69**	Bearing	1	HJ-16-B
70*	Sheave	1	B-57-1
71	Rivet	2	H-4562
72	Block Frame	2	HJ-30
73	Bottom Hook	1	3K8S
74	Capacity Decal	1	675K70
75†	Housing Cover and Oil Seal Assembly (Includes Index Nos. 15 and 16)	1	MA-950
76†	Ratchet Assembly (Includes Index Nos. 20 and 21)	1	MA-901
78†	Housing, Bearings and Oil Seal Assembly (Includes Index Nos. 39, 40, 41 and 43)	1	MA-951
79†	Handle Assembly (Includes Index Nos. 4 thru 10)	1	MA-908
80†	Load Pawl Shaft Assembly (Includes Index Nos. 35, 37 and 38)	1	MA-900
81†	Load Block Sheave and Shaft Assembly (Includes Index Nos. 58, 59, 60 and 61)	1	JF-917
82†	Load Block Sheave and Bearing Assembly (Includes Index Nos. 69 and 70)	1	BB-57-1

* Not sold separately as a repair part. If replacement is required, procure the appropriate following assembly.

** Sold individually as a repair part and as a part of the appropriate following assembly.

† Assembly not indexed on illustration

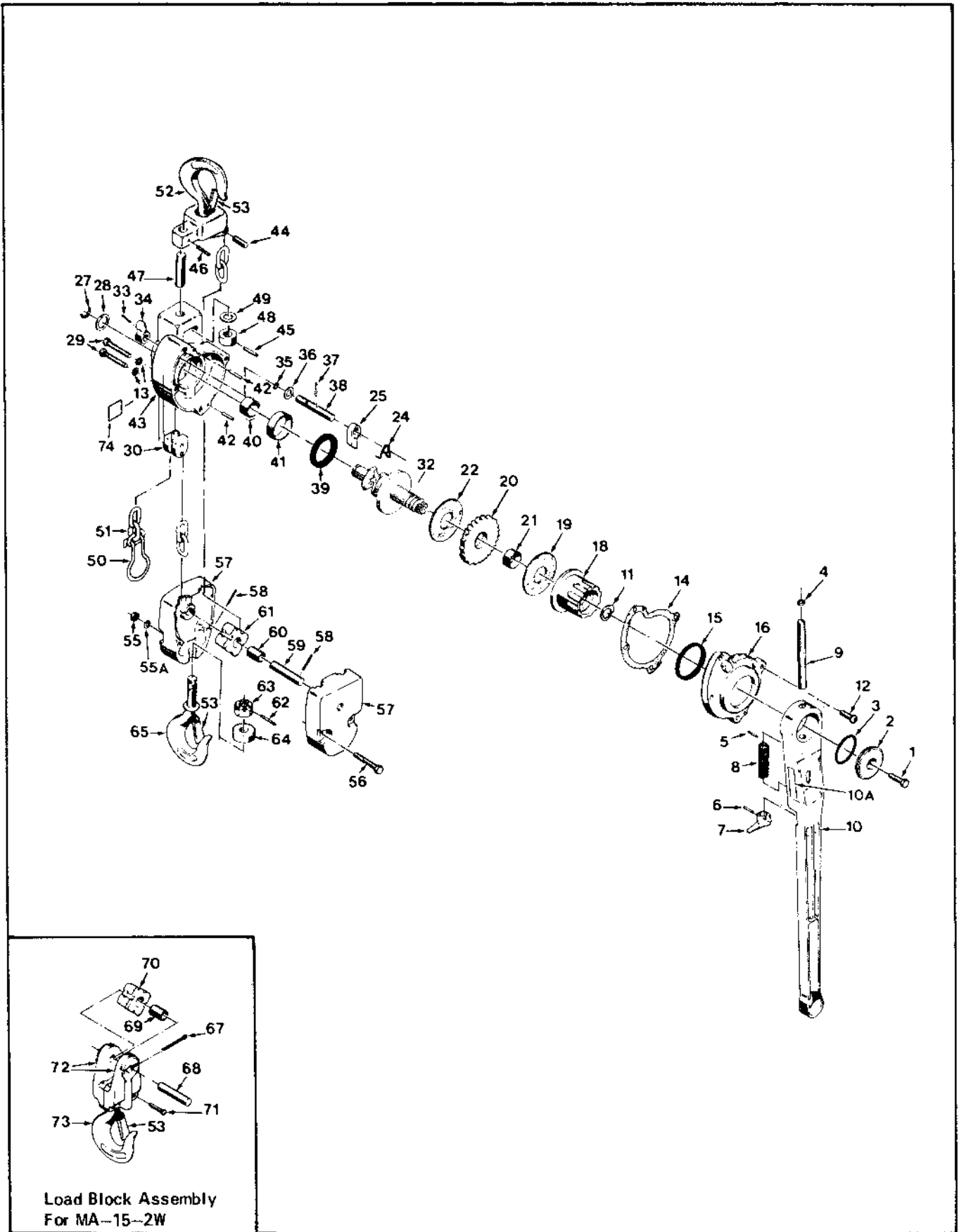

FIGURE 5-2. EXPLODED ILLUSTRATION OF MODEL MA-15-2 AND MA-15-2W HOISTS

PARTS LIST FOR MODEL MA-30 HOIST

Index No.	Part Name	Qty. Req.	Part No.
1	Screw, Retainer Cap	1	H-2989-P
2	Retainer Cap	1	MA-100
3	"O" Ring, Retainer Cap	1	H-5608
4**	Plug, Retainer Cap	1	MA-254
5**	Pin, Handle Pawl Spring	1	H-5249
6**	Pin, Handle Pawl Lever	1	H-5250
7**	Lever, Handle Pawl	1	MA-31
8**	Spring, Handle Pawl	1	MA-311
9**	Handle Pawl Rod	1	MA-4
10**	Handle	1	MA-1
10A	Warning Decal	1	687K6
11	Thread Stop	1	MA-251-1
12	Screw, Cover	4	H-1882-P
14	Gasket, Housing	1	MA-560
15**	Oil Seal, Cover	1	MA-562
16*	Cover, Housing	1	MA-11
18	Hub	1	MA-35
19	Brake Disc, Front	1	MA-580-1
20*	Ratchet	1	MA-7
21**	Bearing, Ratchet	1	MA-530
22	Brake Disc, Rear	1	MA-580
23	Thrust Washer	1	MA-33
24	Spring, Load Pawl	1	MA-310
25	Load Pawl	1	MA-25
27	Screw, Gear Cover	2	H-1886-P
28	Lockwasher	2	H-4138
29	Cover, Gear	1	MA-11-1
30	Screw, Capacity Plate	2	H-2864-P
31	Capacity Plate	1	MA-675
32	Pin, Chain Shedder	2	H-5126
33	Shedder	1	MA-37-1
34	Gear	1	MA-480
35	Pin	1	H-5261
36	Pinion Shaft	1	MAL-483
37	Load Sheave	1	MA-16-5
38	Washer, Thrust	1	MA-253
39	Pin, Load Pawl Lever	1	H-5240
40	Lever, Load Pawl	1	MA-32
41**	"O" Ring, Load Pawl Shaft	1	H-5607

Index No.	Part Name	Qty. Req.	Part No.
42	Washer, Load Pawl Shaft	1	MA-252
43**	Pin, Load Pawl Shaft	1	H-5251
44*	Shaft, Load Pawl	1	MA-26-2
45**	Oil Seal, Pinion Shaft	1	MA-563
46**	Bearing, Pinion Shaft	2	MA-533
47**	Bearing, Load Sheave	1	MA-531-1
48**	Bearing, Load Sheave	1	MA-532
49	Pin, Housing	2	H-5384
50*	Housing	1	MA-18-2
51**	Nut	1	H-3473-P
52**	Swivel Screw	1	MA-718-2
53	Load Chain	1	C-19-10
54	End Ring	1	MA-75
55**	Swivel Frame	2	MA-20-2
56**	Hook Assembly, Bottom (Includes Index No. 57)	1	3K9S
57**	Latch Kit	2	H-7540
58	Hook Assembly, Top (Includes Index No. 57)	1	3K10S
59	Pin, Top Hook	1	H-5232
60	Nut, Top Hook	1	H-3991-P
61	Washer, Top Hook	1	JF-265
62†	Housing Cover and Oil Seal Assembly (Includes Index Nos. 15 and 16)	1	MA-950
63†	Ratchet Assembly (Includes Index Nos. 20 and 21)	1	MA-901
65†	Load Pawl Shaft Assembly (In- cludes Index Nos. 41, 43 and 44)	1	MA-900-2
66†	Handle Assembly (Includes Index Nos. 4 thru 10)	1	MA-908
67†	Housing, Bearings and Oil Seal Assembly (Includes Index Nos. 45, 46, 47, 48 and 50)	1	MA-951-3
68†	Load Block Assembly (Includes Index Nos. 51, 52 and 55 thru 57)	1	MA-913-21

* Not sold separately as a repair part. If replacement is required, procure the appropriate following assembly.

** Sold individually as a repair part and as a part of the appropriate following assembly

† Assembly not indexed on illustration.

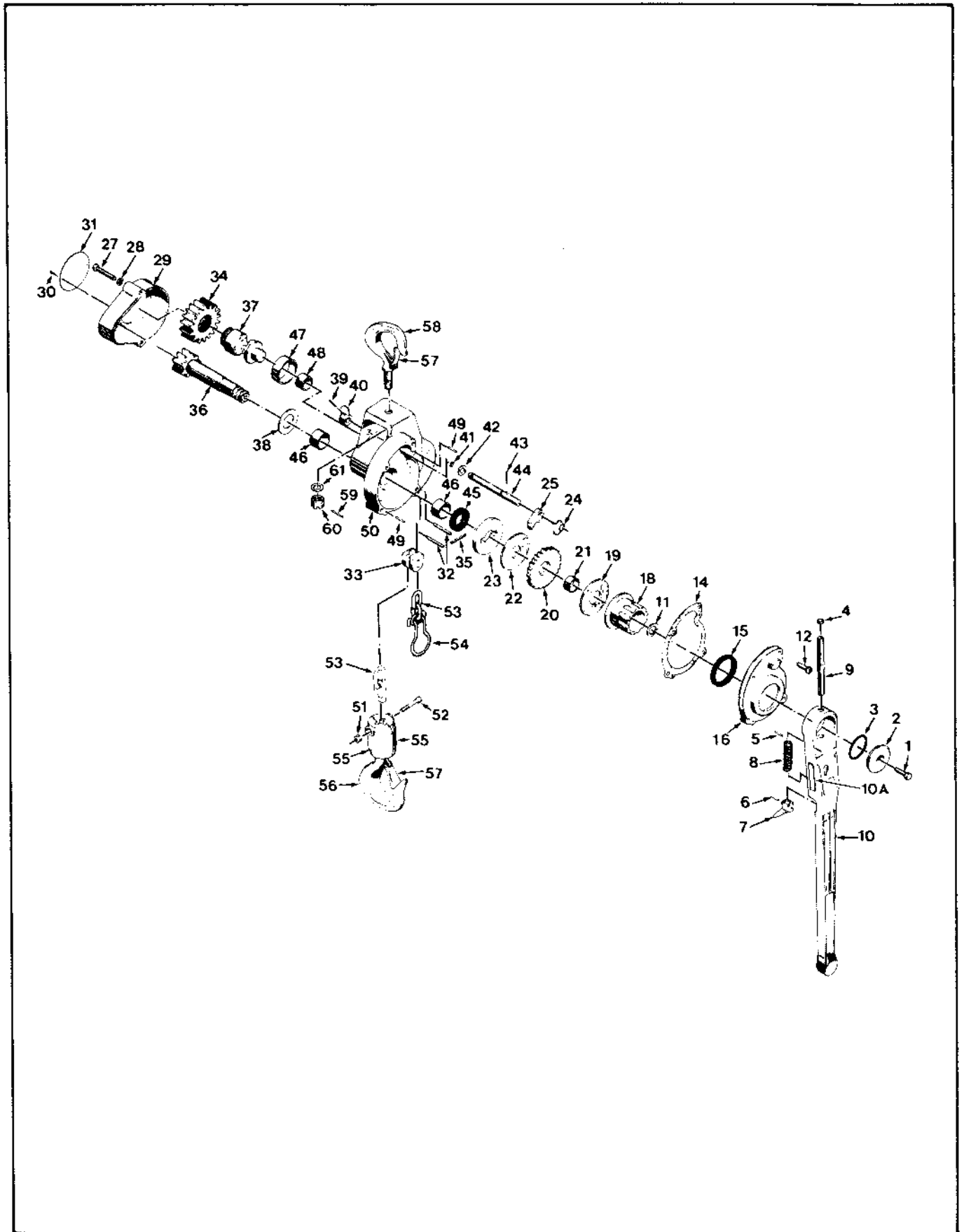

FIGURE 5-3. EXPLODED ILLUSTRATION OF MODEL MA-30 HOIST

PARTS LIST FOR MODEL MA-30-2 AND MA-30-2W HOISTS

Index No.	Part Name	Qty. Req.	Part No.	Index No.	Part Name	Qty. Req.	Part No.
1	Screw, Retainer Cap	1	H-2989-P	61	End Ring	1	MA-75
2	Retainer Cap	1	MA-100	62	Load Chain	1	C-19-10
3	"O" Ring, Retainer Cap	1	H-5608	63†	Bottom Block Assembly (Consists of Index Nos. 64 thru 75)		
4**	Plug, Handle	1	MA-254	64	Nut	1	MA-914-4
5**	Pin, Handle Pawl Spring	1	H-5249	65	Screw	2	H-3964-P
6**	Pin, Handle Pawl Lever	1	H-5250	66	Load Block Frame	2	MA-29
7**	Lever, Handle Pawl	1	MA-31	67**	Pin	1	H-5234
8**	Spring, Handle Pawl	1	MA-311	68**	Load Block Shaft	1	MA-101
9**	Handle Pawl Rod	1	MA-4	69**	Bearing	1	A-28-B
10**	Handle	1	MA-1	70*	Sheave	1	SP-28
10A	Warning Decal	1	687K6	71**	Pin	1	H-5243
11	Thread Stop	1	MA-251-1	72**	Nut	1	H-3922-P
12	Screw, Cover	4	H-1882-P	73**	Hook Washer	1	CB-253
14	Gasket, Housing	1	MA-560	74**	Thrust Bearing	1	CB-510
15**	Oil Seal, Cover	1	MA-562	75**	Bottom Hook (Includes Index No. 59)	1	SHL-6
16*	Cover, Housing	1	MA-11	76†	Bottom Block Assembly (Consists of Index Nos. 77 thru 83)		
18	Hub	1	MA-35	77	Cotter Pin	2	SSP-30-SH H-5022
19	Brake Disc, Front	1	MA-580-1	78	Load Block Shaft	1	F-28-A-1
20*	Ratchet	1	MA-7	79**	Bearing	1	A-28-B
21**	Bearing, Ratchet	1	MA-530	80*	Sheave	1	SP-28
22	Brake Disc, Rear	1	MA-580	81	Rivet	2	H-4551
23	Thrust Washer	1	MA-33	82	Load Block Frame	2	HJ-130
24	Spring, Load Pawl	1	MA-310	83	Bottom Hook (Includes Index No. 59 and Nut)	1	SHL-11W
25	Load Pawl	1	MA-25	84†	Housing Cover and Oil Seal Assembly (Includes Index Nos. 15 and 16)	1	MA-950
27	Screw, Gear Cover	2	H-1886-P	85†	Ratchet Assembly (Includes Index Nos. 20 and 21)	1	MA-901
28	Lockwasher	2	H-4138	87†	Load Pawl Shaft Assembly (Includes Index Nos. 41, 43 and 44)	1	MA-900-2
29	Cover, Gear	1	MA-11-1	88†	Handle Assembly (Includes Index Nos. 4 thru 10)	1	MA-908
30	Screw, Capacity Plate	2	H-2864-P	89†	Housing, Bearings and Oil Seal Assembly (Includes Index Nos. 45, 46, 47, 48 and 50)	1	MA-951-3
31	Capacity Plate	1	CB-675-3	90†	Load Block Shaft Assembly (Includes Index Nos. 67 and 68)	1	MA-903
32	Pin, Chain Shedder	2	H-5126	91†	Bottom Hook Assembly (Includes Index Nos. 71 thru 75)	1	MA-912-2
33	Shedder	1	MA-37-1	92†	Outrigger Assembly (Includes Index Nos. 55 thru 60)	1	MA-915-5
34	Gear	1	MA-480	93†	Load Block Sheave and Bearing Assembly (Includes Index Nos. 79 and 80)	1	SSP-28
35	Pin	1	H-5261	94†	Load Block Sheave and Bearing Assembly (Includes Index Nos. 69 and 70)	1	SSP-28
36	Pinion Shaft	1	MAL-483	95†	Load Block Assembly (Model MA-30-2)	1	MA-914-4
37	Load Sheave	1	MA-16-5	96†	Load Block Assembly (Model MA-30-2W)	1	SSP-30-SH
38	Washer, Thrust	1	MA-253				
39	Pin, Load Pawl Lever	1	H-5240				
40	Lever, Load Pawl	1	MA-32				
41**	"O" Ring, Load Pawl Shaft	1	H-5607				
42	Washer, Load Pawl Shaft	1	MA-252				
43**	Pin, Load Pawl Shaft	1	H-5251				
44*	Shaft, Load Pawl	1	MA-26-2				
45**	Oil Seal, Pinion Shaft	1	MA-563				
46**	Bearing, Pinion Shaft	2	MA-533				
47**	Bearing, Load Sheave	1	MA-531-1				
48**	Bearing, Load Sheave	1	MA-532				
49	Pin, Housing	2	H-5384				
50*	Housing	1	MA-18-2				
51	Pin, Dead End	1	H-5131				
52	Screw, Outrigger	2	H-2425-P				
53	Lockwasher	2	H-4136				
54	Keeper	1	MA-43-1				
55**	Pin, Top Hook	1	H-5243				
56**	Nut, Top Hook	1	H-3922-P				
57**	Washer	1	CB-253				
58**	Top Hook Assembly (Includes Index No. 59)	1	SHL-5				
59**	Latch Kit	2	H-7544				
60**	Outrigger	1	MA-42				

* Not sold separately as a repair part. If replacement is required, procure the appropriate following assembly.

** Sold individually as a repair part and as a part of the appropriate following assembly.

† Assembly not indexed on illustration.

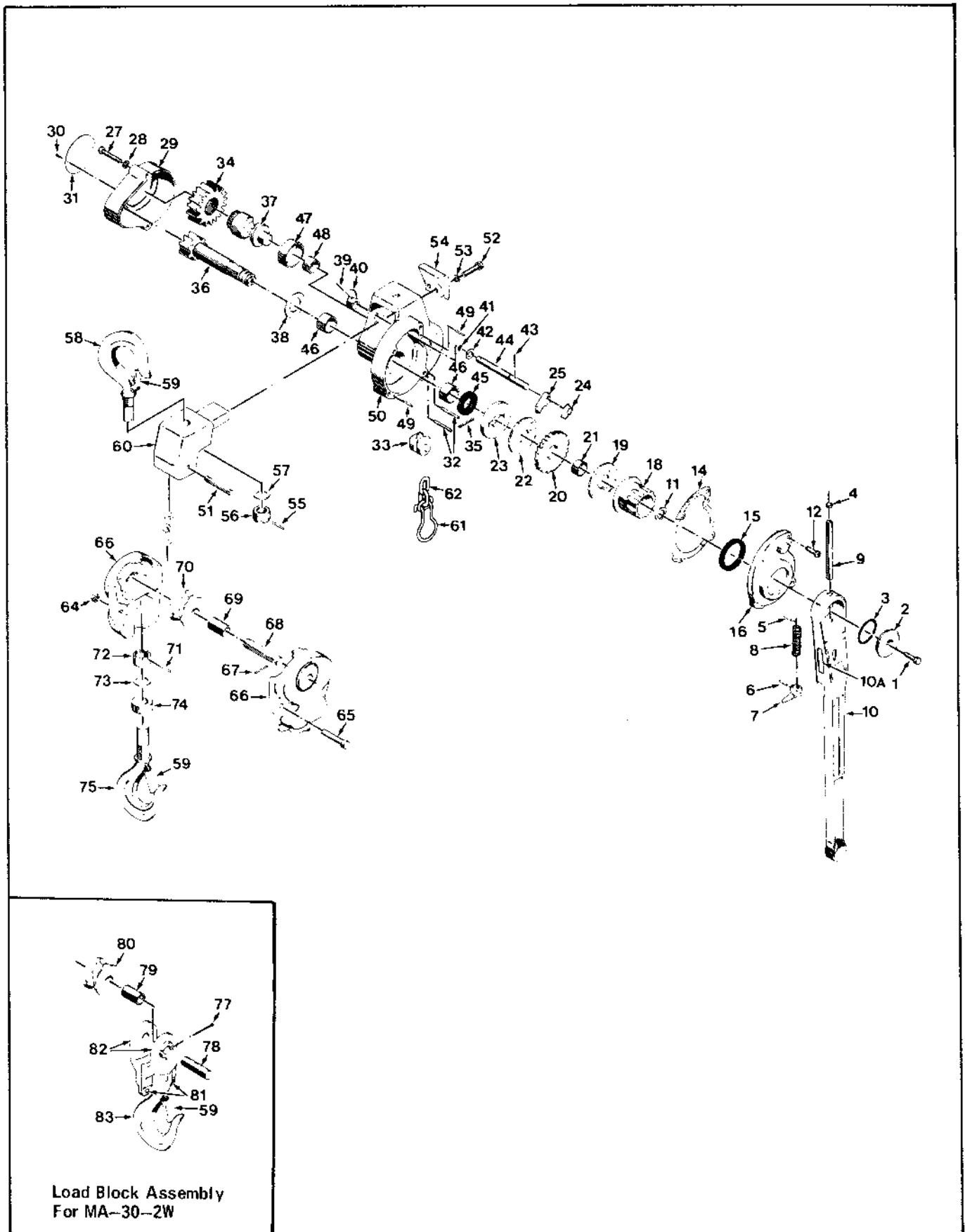

FIGURE 5-4. EXPLODED ILLUSTRATION OF MODEL MA-30-2 AND MA-30-2W HOISTS

PARTS LIST FOR MODEL MA-30-3 HOIST

Index No.	Part Name	Qty. Req.	Part No.
1	Screw, Retainer Cap	1	H-2989-P
2	Retainer Cap	1	MA-100
3	"O" Ring, Retainer Cap	1	H-5608
4**	Plug, Handle	1	MA-254
5**	Pin, Handle Pawl Spring	1	H-5249
6**	Pin, Handle Pawl Lever	1	H-5250
7**	Lever, Handle Pawl	1	MA-31
8**	Spring, Handle Pawl	1	MA-311
9**	Handle Pawl Rod	1	MA-4
10**	Handle	1	MA-1
10A	Warning Decal	1	687K6
11	Thread Stop	1	MA-251-1
12	Screw, Cover	4	H-1882-P
14	Gasket, Housing	1	MA-560
15**	Oil Seal, Cover	1	MA-562
16*	Cover, Housing	1	MA-11
18	Hub	1	MA-35
19	Brake Disc, Front	1	MA-580-1
20*	Ratchet	1	MA-7
21**	Bearing, Ratchet	1	MA-530
22	Brake Disc, Rear	1	MA-580
23	Thrust Washer	1	MA-33
24	Spring, Load Pawl	1	MA-310
25	Load Pawl	1	MA-25
27	Screw, Gear Cover	2	H-1886-P
28	Lockwasher	2	H-4138
29	Cover, Gear	1	MA-11-1
30	Screw, Capacity Plate	2	H-2864-P
31	Capacity Plate	1	MA-675-1
32	Pin, Chain Shedder	2	H-5126
33	Shedder	1	MA-37-1
34	Gear	1	MA-480
35	Pin	1	H-5261
36	Pinion Shaft	1	MAL-483
37	Load Sheave	1	MA-16-5
38	Washer, Thrust	1	MA-253
39	Pin, Load Pawl Lever	1	H-5240
40	Lever, Load Pawl	1	MA-32
41**	"O" Ring, Load Pawl Shaft	1	H-5607
42	Washer, Load Pawl Shaft	1	MA-252
43**	Pin, Load Pawl Shaft	1	H-5251
44*	Shaft, Load Pawl	1	MA-26-2
45**	Oil Seal, Pinion Shaft	1	MA-563
46**	Bearing, Pinion Shaft	2	MA-533
47**	Bearing, Load Sheave	1	MA-531-1
48**	Bearing, Load Sheave	1	MA-532
49	Pin, Housing	2	H-5384
50*	Housing	1	MA-18-2
51**	Pin	1	H-5235
52**	Nut	1	H-3924-P
53**	Hook Washer	1	CB-252-1
54**	Top Hook (Includes Index No. 55)	1	SHL-7
55	Latch Kit	2	H-7545

Index No.	Part Name	Qty. Req.	Part No.
56	Screw	2	H-2425-P
57	Lockwasher	2	H-4136
58	Keeper	1	MA-43-1
59**	Pin	1	H-5234
60**	Shaft	1	MA-101
61**	Bearing	1	A-28-B
62*	Sheave	1	SP-28
63**	Outrigger	1	MA-42-1
64	End Ring	1	MA-75
65	Load Chain	1	C-19-10
66	Nut	1	H-3964-P
67†	Bottom Hook and Block Assembly (Consists of Index Nos. 68 thru 79)	2	MA-914-5
68	Nut	2	H-3965-P
69	Screw	2	H-2411-P
70	Load Block Frame	1	MA-29-1
71**	Pin	1	H-5234
72**	Load Block Shaft	1	MA-101
73**	Bearing	1	A-28-B
74*	Sheave	1	SP-28
75**	Pin	1	H-5235
76**	Nut	1	H-3924-P
77**	Hook Washer	1	CB-252-2
78**	Thrust Bearing	1	CB-511
79**	Bottom Hook (Includes Index No. 55)	1	SHL-8
80	Dead End Screw	1	MA-700-1
81†	Housing Cover and Oil Seal Assembly (Includes Index Nos. 15 and 16)	1	MA-950
82†	Ratchet Assembly (Includes Index Nos. 20 and 21)	1	MA-901
84†	Load Pawl Shaft Assembly (Includes Index Nos. 41, 43 and 44)	1	MA-900-2
85†	Handle Assembly (Includes Index Nos. 4 thru 10)	1	MA-908
86†	Housing, Bearings and Oil Seal Assembly (Includes Index Nos. 45, 46, 47, 48 and 50)	1	MA-951-3
87†	Idler Sheave and Bearing Assembly (Includes Index Nos. 61 and 62)	1	SSP-28
88†	Load Block Sheave and Bearing Assembly (Includes Index Nos. 73 thru 74)	1	SSP-28
89†	Load Block Shaft Assembly (Includes Index Nos. 71 and 72)	1	MA-903
90†	Bottom Hook Assembly (Includes Index Nos. 75 thru 79)	1	MA-912-3
91†	Outrigger Assembly (Includes Index Nos. 51 thru 63)	1	MA-915-6
92†	Load Block Assembly (Includes Index Nos. 68 thru 79)	1	MA-914-5

* Not sold separately as a repair part. If replacement is required, procure the appropriate following assembly

** Sold individually as a repair part and as a part of the appropriate following assembly

† Assembly not indexed on illustration.

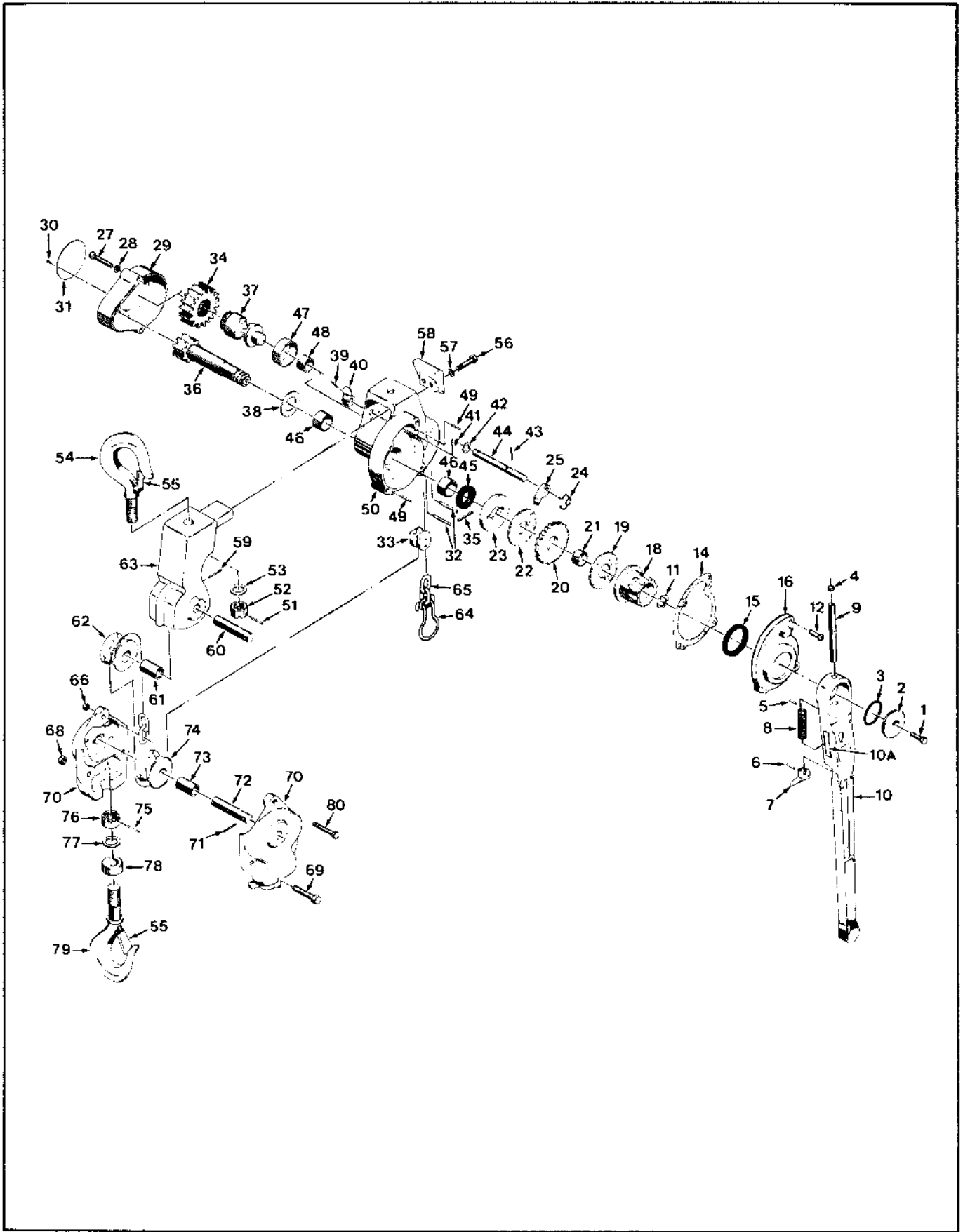

FIGURE 5-5. EXPLODED ILLUSTRATION OF MODEL MA-30-3 HOIST

PARTS LIST FOR MODEL MA-30-4 HOIST

Index No.	Part Name	Qty. Req.	Part No.
1	Screw, Retainer Cap	1	H-2989-P
2	Retainer Cap	1	MA-100
3	"O" Ring, Retainer Cap	1	H-5608
4**	Plug, Handle	1	MA-254
5**	Pin, Handle Pawl Spring	1	H-5249
6**	Pin, Handle Pawl Lever	1	H-5250
7**	Lever, Handle Pawl	1	MA-31
8**	Spring, Handle Pawl	1	MA-311
9**	Handle Pawl Rod	1	MA-4
10**	Handle	1	MA-1
10A	Warning Decal	1	687K6
11	Thread Stop	1	MA-251-1
12	Screw, Cover	4	H-1882-P
14	Gasket, Housing	1	MA-560
15**	Oil Seal, Cover	1	MA-562
16*	Cover, Housing	1	MA-11
18	Hub	1	MA-35
19	Brake Disc, Front	1	MA-580-1
20*	Ratchet	1	MA-7
21**	Bearing, Ratchet	1	MA-530
22	Brake Disc, Rear	1	MA-580
23	Thrust Washer	1	MA-33
24	Spring, Load Pawl	1	MA-310
25	Load Pawl	1	MA-25
27	Screw, Gear Cover	2	H-1886-P
28	Lockwasher	2	H-4138
29	Cover, Gear	1	MA-11-1
30	Screw, Capacity Plate	2	H-2864-P
31	Capacity Plate	1	CB-675-4
32	Pin, Chain Shedder	2	H-5126
33	Shedder	1	MA-37-1
34	Gear	1	MA-480
35	Pin	1	H-5261
36	Pinion Shaft	1	MAL-483
37	Load Sheave	1	MA-16-5
38	Washer, Thrust	1	MA-253
39	Pin, Load Pawl Lever	1	H-5240
40	Lever, Load Pawl	1	MA-32
41**	"O" Ring, Load Pawl Shaft	1	H-5607
42	Washer, Load Pawl Shaft	1	MA-252
43**	Pin, Load Pawl Shaft	1	H-5251
44*	Shaft, Load Pawl	1	MA-26-2
45**	Oil Seal, Pinion Shaft	1	MA-563
46**	Bearing, Pinion Shaft	2	MA-533
47**	Bearing, Load Sheave	1	MA-531-1
48**	Bearing, Load Sheave	1	MA-532
49	Pin, Housing	2	H-5384
50*	Housing	1	MA-18-2
51**	Pin	1	H-5235
52**	Nut	1	H-3924-P
53**	Hook Washer	1	CB-252-1
54**	Top Hook (Includes Index No. 55)	1	SHL-9
55	Latch Kit	2	H-7545

Index No.	Part Name	Qty. Req.	Part No.
56	Screw	2	H-2425-P
57	Lockwasher	2	H-4136
58	Keeper	1	MA-43-1
59**	Pin	1	H-5234
60**	Load Block Shaft	1	MA-101
61**	Bearing	1	A-28-B
62*	Sheave	1	SP-28
63**	Outrigger	1	MA-42-2
64	Pin	1	H-5131
65	End Ring	1	MA-75
66	Load Chain	1	C-19-10
67†	Bottom Hook and Block Assembly (Consists of Index Nos. 68 thru 79)	1	MA-914-6
68	Nut	2	H-3966-P
69	Screw	2	H-2419-P
70	Load Block Frame	2	MA-29-2
71**	Pin	2	H-5234
72**	Load Block Shaft	2	MA-101
73**	Bearing	2	A-28-B
74*	Sheave	2	SP-28
75**	Pin	1	H-5235
76**	Nut	1	H-3924-P
77**	Hook Washer	1	MA-103
78**	Thrust Bearing	1	CB-511-1
79**	Bottom Hook (Includes Index No. 55)	1	SHL-10
80†	Housing Cover and Oil Seal Assembly (Includes Index Nos. 15 and 16)	1	MA-950
81†	Ratchet Assembly (Includes Index Nos. 20 and 21)	1	MA-901
83†	Load Pawl Shaft Assembly (Includes Index Nos. 41, 43 and 44)	1	MA-900-2
84†	Handle Assembly (Includes Index Nos. 4 thru 10)	1	MA-908
85†	Housing, Bearings and Oil Seal Assembly (Includes Index Nos. 45, 46, 47, 48 and 50)	1	MA-951-3
86†	Idler Sheave and Bearing Assembly (Includes Index Nos. 61 and 62)	1	SSP-28
87†	Load Block Sheave and Bearing Assembly (Includes Index Nos. 73 and 74)	2	SSP-28
88†	Load Block Shaft Assembly (Includes Index Nos. 71 and 72)	2	MA-903
89†	Bottom Hook Assembly (Includes Index Nos. 75 thru 79)	1	MA-912-4
90†	Outrigger Assembly	1	MA-915-7
91†	Load Block Assembly (Includes Index Nos. 68 thru 79)	1	MA-914-6

* Not sold separately as a repair part. If replacement is required, procure the appropriate following assembly.

** Sold individually as a repair part and as a part of the appropriate following assembly

† Assembly not indexed on illustration.

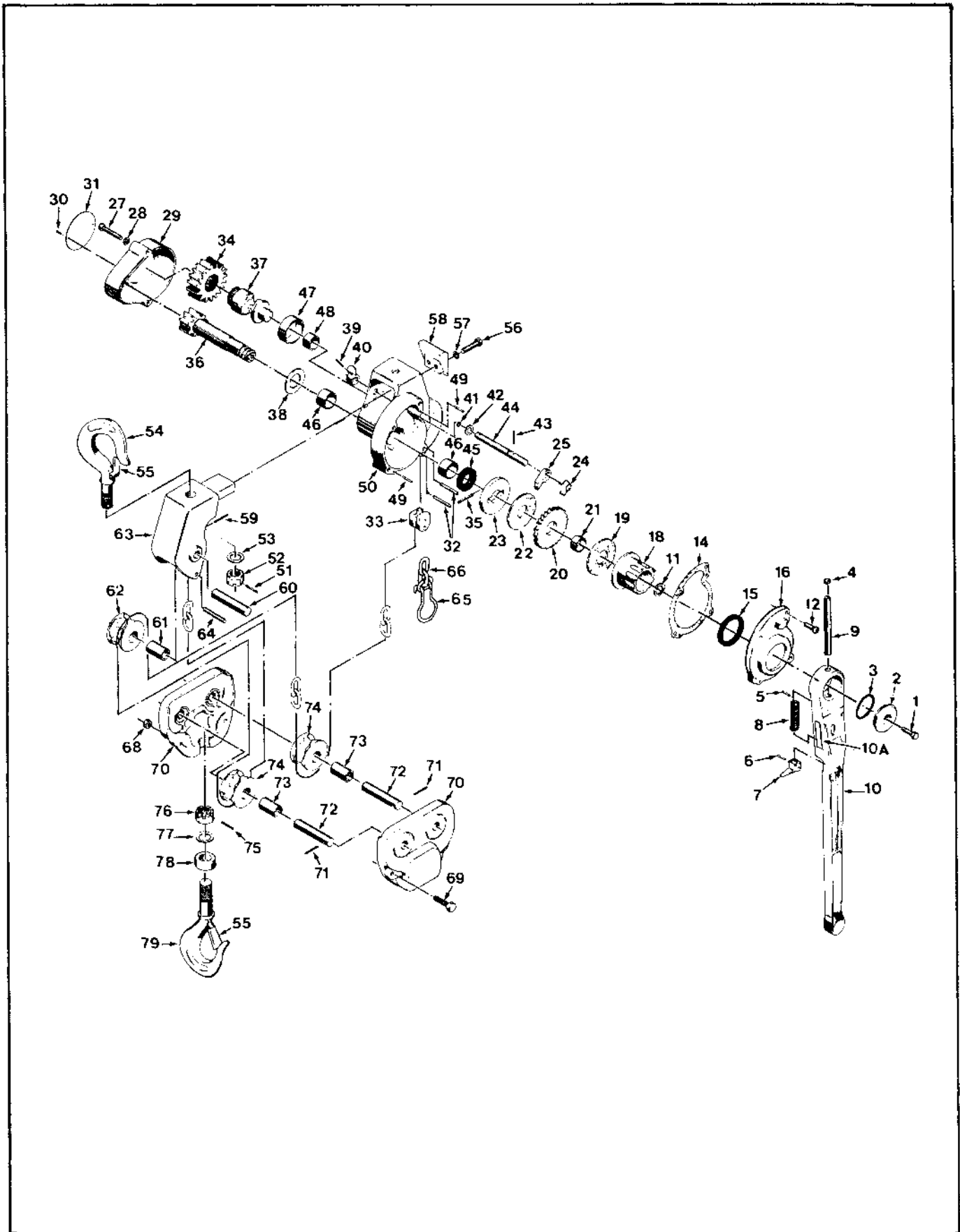

FIGURE 5-6. EXPLODED ILLUSTRATION OF MODEL MA-30-4 HOIST

NOTES

DO'S AND DO NOT'S

Manually Lever Operated Chain Hoists

The following warnings and operating practices are intended to avoid unsafe hoisting practices which might lead to personal injury or property damage.

These recommendations apply to all manually lever operated chain hoists used for lifting, pulling, and tensioning type applications.

WARNING: TO AVOID INJURY

1. **DO** read the Hoist Manufacturer's Operating and Maintenance Instructions.
2. **DO** be familiar with operating controls, procedures, and warnings on the unit.
3. **DO** make sure that the unit is securely attached to a suitable support before applying load.
4. **DO** maintain firm footing or be otherwise secured when operating unit.
5. **DO** make sure that load slings or other approved sling attachments are properly sized and seated in the hook saddle.
6. **DO** make sure the hook latches, if used, are closed and not supporting any part of the load.
7. **DO** make sure that load is free to move and will clear all obstructions.
8. **DO** take up slack carefully, check load balance, move the load a few inches, and check load holding action before continuing.
9. **DO** make sure all persons stay clear of the supported load.
10. **DO** avoid swinging of load or load hook.
11. **DO** protect load chain from weld spatter or other damaging contaminants.
12. **DO** avoid lever "fly-back" by keeping a firm grip on the lever until operating stroke is completed and the lever is at rest.
13. **DO** promptly report any malfunction, unusual performance, or damage of the unit.
14. **DO** inspect unit regularly, replace damaged or worn parts, and keep appropriate records of maintenance.
15. **DO** use the Hoist Manufacturer's recommended parts when repairing unit.
16. **DO** use hook latches wherever possible.
17. **DO** apply lubricant to load chain as recommended by the Hoist Manufacturer.

"DO's and Do Not's" reprinted with the permission of the Hoist Manufacturer's Institute.

18. **DO NOT** lift or pull more than rated load.
19. **DO NOT** use the hoist load limiting or warning device to measure the load.
20. **DO NOT** use damaged unit or unit that is not working correctly.
21. **DO NOT** use unit with twisted, kinked, damaged, or worn chain.
22. **DO NOT** apply a load unless chain is properly seated in chain wheel(s) or sprocket(s).
23. **DO NOT** use load chain as a sling or wrap chain around a load.
24. **DO NOT** apply a load if any binding prevents equal loading on all load supporting chains.
25. **DO NOT** apply the load to the tip of the hook.
26. **DO NOT** operate unit when it is restricted from adjusting itself to form a straight line with the direction of loading.
27. **DO NOT** operate except with hand power.
28. **DO NOT** permit more than one operator to pull on lever at the same time.
29. **DO NOT** operate with any lever extension (cheater bar).
30. **DO NOT** allow your attention to be diverted from operating the unit.
31. **DO NOT** operate unit beyond limits of load chain travel.
32. **DO NOT** attempt to "free chain" unit with any load applied.
33. **DO NOT** use hoist to lift, support, or transport people.
34. **DO NOT** lift loads over people.
35. **DO NOT** leave a load supported by the unit unattended unless specific precautions have been taken.
36. **DO NOT** allow unit to be subjected to sharp contact with other units, structures or objects through misuse.
37. **DO NOT** allow the chain or hook to be used as a ground for welding.
38. **DO NOT** allow the chain or hook to be touched by a live welding electrode.
39. **DO NOT** remove or obscure the warnings on the unit.
40. **DO NOT** adjust or repair a unit unless qualified to perform such maintenance.
41. **DO NOT** attempt to lengthen the load chain or repair damaged load chain.

DUFF-NORTON HAS ALL YOU NEED TO HANDLE A VARIETY OF TOUGH INDUSTRIAL, MAINTENANCE AND CONSTRUCTION LIFTING JOBS.

Coffing® is America's first name in quality, industrial hoisting equipment. Nowhere else can you find such a broad range of hoists with such consistent high-quality construction and durability. A detailed

product catalog is available from your local Coffing hoist distributor, Duff-Norton District Sales Manager, or by writing directly to Duff-Norton Company. **Ask for Catalog 200, it includes:**

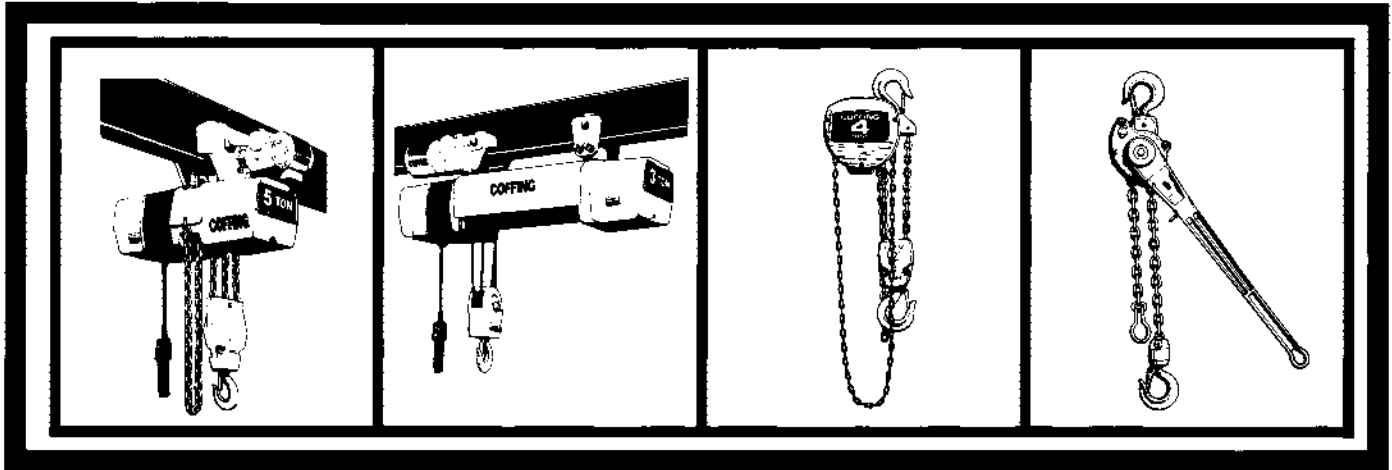

Coffing® Electric Chain Hoists

Load ratings from ¼ to 5 tons. More standard features than any comparable hoist. Two-speed options available; 47 models to choose.

Coffing® Electric Wire Rope Hoists.

Low headroom units with load ratings from ½ to 3 tons. Choice of rigid hook or lug suspensions, plus plain, geared or motorized trolleys. Single or two speed options and variety of standard lifts. 35 models.

Coffing® Hand Chain Hoists.

Designed for light weight and long life with minimum maintenance. Optional capacity limiter available in some models. 99 models in rated loads from ½ to 25 tons.

Coffing® Lever Hoists.

A variety of mechanisms and rated loads from ¼ to 15 tons; in 36 models for both conventional and special purpose applications.

WARNING: The equipment shown in this manual is intended for industrial use only and should not be used to lift, support, or otherwise transport people, or to suspend unattended loads over people.

AVAILABLE FROM YOUR LOCAL DUFF NORTON COFFING®/DUFF LYNX® HOIST DISTRIBUTOR:



P.O. Box 7010
Charlotte, NC 28241-7010

Customer Service (704) 588-2720
Parts Service (704) 588-2323
FAX (704) 588-1994
Telex 575188

Duff-Norton Manufactures:
Coffing® Hoists • Duff Lynx® Hoists and Pullers • Duff-Norton® Actuators
Mechanical Jacks • Rotating Joints